



UNILOCK®

TECH GUIDE

Paving Stones
Retaining Walls



ACKNOWLEDGEMENTS

The content of this manual was developed using the vast experience acquired by the Unilock® sales force during more than 30 years in the precast concrete industry. Selected information contained herein is taken from the Interlocking Concrete Pavement Institute (ICPI) students' manual and from Risi Stone Systems literature.

Unilock® has attempted to ensure that all information contained in this guide is correct. However, there is the possibility that this guide may contain errors. Review all critical designs with your local Unilock® representative prior to construction. Final determination of the suitability of any information or material is the sole responsibility of the user. Products mentioned herein are subject to regional availability. Check for product availability at your Unilock® location.

© 2006 Hengestone Holdings, Inc.

Hengestone Holdings, Inc. is the owner or authorized user of all trademarks listed herein.



TABLE OF CONTENTS

ACKNOWLEDGEMENTS	i
TABLE OF CONTENTS	ii
INTRODUCTION	1
Overview of Interlocking Concrete Pavements	1
<i>Concept</i>	1
<i>Advantages</i>	1
<i>Components</i>	2
<i>Typical cross sections</i>	3
<i>Paver selection chart</i>	4
Overview of Segmental Retaining Walls	6
<i>Concept</i>	6
<i>Advantages</i>	6
<i>Components</i>	7
<i>Classification of Segmental Retaining Walls</i>	7
<i>Retaining wall selection chart</i>	9
PAVER AND WALL INSTALLATION	10
Design and Planning	10
<i>Sketch or plan</i>	10
<i>Engineering design and certification</i>	10
<i>Flow of materials</i>	10
<i>Utilities location</i>	11
Base Construction	11
<i>Layout for excavation</i>	11
<i>Excavation</i>	13
<i>Soil conditions</i>	14
<i>Site drainage</i>	14
<i>Soil compaction</i>	16
<i>Base installation</i>	17
<i>Quality of base materials</i>	18
<i>Base thickness</i>	19
<i>Base compaction</i>	19
PAVER INSTALLATION	23
Edge Restraints	23
<i>Edge restraint installation</i>	25
Bedding Course	26
<i>Bedding course installation</i>	26
Pavers Installation	28
<i>Manual installation</i>	29
<i>Step-by-step manual paver installation</i>	30
<i>Mechanical installation</i>	31

TABLE OF CONTENTS

<i>Cutting</i>	31
<i>Cutting tools</i>	31
<i>Compacting pavers</i>	34
<i>Jointing sand</i>	36
<i>Cleaning and finishing</i>	37
GRAVITY RETAINING WALL INSTALLATION	38
<i>Base preparation</i>	38
<i>Installing the first course</i>	40
<i>Stack units</i>	40
<i>Backfill</i>	41
<i>Coping unit</i>	41
<i>Finish grading</i>	41
REINFORCED RETAINING WALL INSTALLATION	43
<i>Geogrid reinforcement</i>	43
<i>Backfill over geogrid</i>	43
DETAILS	45
Splitting	45
Corners	46
<i>Outside corners</i>	46
<i>Inside corners</i>	47
Curves	48
<i>Inside curves – Concave walls</i>	48
<i>Outside curves</i>	48
Steps	49
<i>Most common configurations</i>	50
<i>Steps installation tips</i>	52
Planters	53
Pillars	54
PAVERS MAINTENANCE GUIDE	55
Cleaning	55
<i>Grease and oil stains</i>	56
<i>Efflorescence on concrete</i>	56
<i>Rust stains</i>	57
<i>Tar, rubber and paint stains</i>	57
Sealing	57
<i>Solvent and water base protective sealer</i>	58
<i>Joint sand stabilizer and paver sealer</i>	58
<i>Polymeric sand</i>	58
<i>Use of chemicals & acids</i>	59

As North America's premier paving stone and retaining wall manufacturer, Unilock® is a dynamic organization at the forefront of the commercial and residential concrete landscape products industry. Our range of products, services and expertise is continually expanding. Whether you are building a complete streetscape or a residential walkway, patio or driveway, Unilock® can provide you with a range of shapes, colors and textures second to none within the precast concrete industry.

This manual is a basic guide for the construction of any type of project involving paving stones and segmental retaining walls. Hands-on training is also available at Unilock® Installation & Design Seminars. For a listing of seminars near you, visit www.unilock.com.

Overview of Interlocking Concrete Pavements

Concept

Interlocking concrete pavements are generally composed of a surface consisting of precast modular concrete units of varying shapes, colors and textures. These are placed over a graded sand and gravel base and interlocked with bedding and joint sand, which can be constructed over a variety of sub-bases. Because they work as a flexible pavement, they can flex with minor movements in the base without cracking, making them an ideal pavement for North America's climate. This uniqueness gives them a distinct advantage over asphalt and poured concrete.

Advantages

Concrete paving stones offer a great variety of advantages over all other types of paving products.

- *Durability* - The combination of high density, high compressive strength and low absorption rate makes concrete paving stones highly resistant to salt scaling, a common problem with some types of concrete. This also makes paving stones excellent for frequent and heavy loading.
- *Reusable* - If the pavers must be removed in order to correct a pavement problem, or to allow utility installation or repair, the pavers are completely reusable.
- *Aesthetics* - The visual impact of paving stones adds character and charm to any installation. With interlocking pavers, color, shape and texture can be incorporated to complement any project design.
- *Freeze-thaw resistance* - Frost damage is virtually nonexistent. The joints between the paver units absorb any movement caused by frost.

- *Below ground access* - Pavers can be removed and reinstalled without any visual or functional changes. This is ideal for utility access below ground.
- *Skid resistance* - The surface texture of pavers gives superior traction in pedestrian, automotive and pool applications.
- *Economics* - Paving stones offer an economical alternative to other types of pavement especially over the long term. When maintenance and replacement costs are considered, other forms of paving are usually more expensive.
- *Maintenance* - With proper installation, pavers require low maintenance.
- *Accessories* - Accessory products for pavers, such as lights, are available to transform outdoor spaces into more functional areas.
- *Modularity* - Paving stones can be installed in a variety of patterns, including curves, straight lines and intricate designs, and add vitality to almost any environment. The combination of compatible shapes, sizes and colors gives the installer the opportunity to do "Paver Quilting®".
- *Ready to use* - They may be used immediately upon completion of installation.

Components

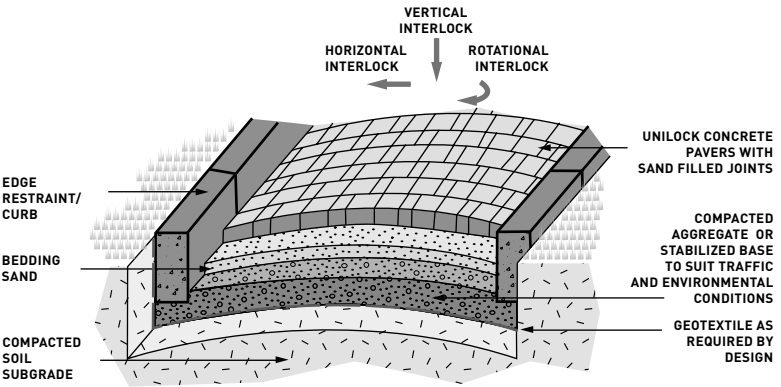

Figure 1. Typical components of an interlocking concrete pavement system.

The unique aspect of concrete pavers is that they interlock to help spread any load points. There are three ways pavers interlock: Vertical, Horizontal, and Rotational. (Figure 1) Vertical interlock is achieved by the shear transfer of loads to surrounding units through the sand in the joints. Horizontal is maintained by the pavers being of sufficient thickness, placed closely together, and restrained by a curb from lateral forces. Rotational interlock is achieved through the use of laying patterns that disperse forces from braking, turning and accelerating vehicles.

Typical cross sections

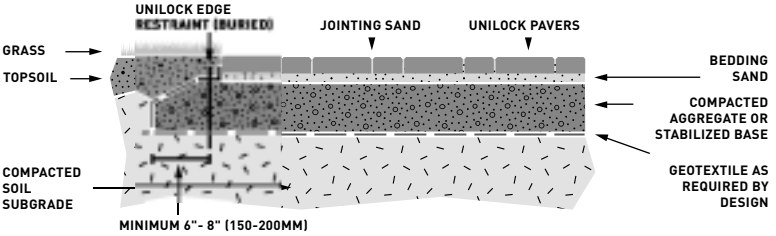

Figure 2. Paver installation with PVC or aluminum edge restraint

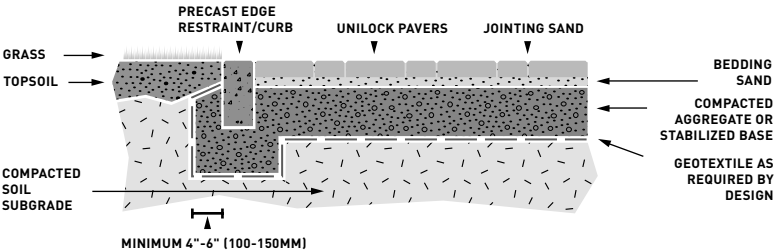

Figure 3. Paver installation with precast or cast-in-place curb unit

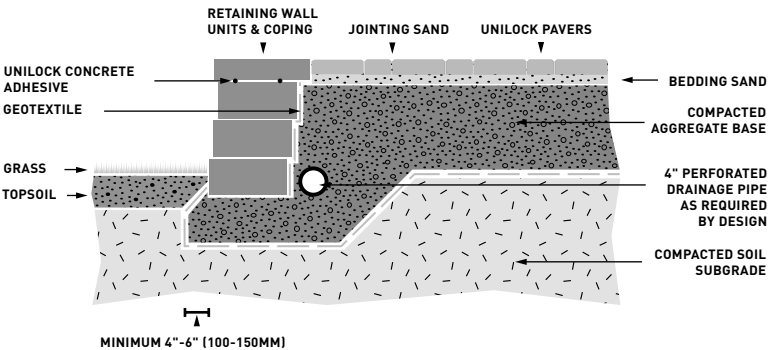

Figure 4. Patio/Terrace installation with wall units and coping

Paver selection chart

Table 1: Unilock® pavers selection chart

SYSTEM	FINISH	POSSIBLE APPLICATIONS					
		PEDESTRIAN	RESIDENTIAL VEHICULAR	INDUSTRIAL VEHICULAR	ENVIRONMENTAL	PAVER QUILTING	CIRCLES & FANS
Anchorlock®	S		√	√			
Antara™	DW	√	√			√	√
Aquaterra®	S		√	√	√		
Brussels Block®	W	√	√			√	√
Camelot™	S	√	√				
Canterbury™	S	√	√				
Cassova™	DW	√	√			√	
Chesapeake Cobble™	W	√	√				√
Classico®	S	√	√				√
Cobblestone™	S	√	√				
Copthorne™	T	√	√			√	
Cortina®	D	√	√				
Courtstone™	C	√	√			√	
Double Holland™	S	√	√			√	
Dura-Mat™	S		√		√		
Ecoloc®	S			√	√		
Eco-Optiloc®	S			√	√		
Europaver®	S	√	√	√		√	
Fullnose Edger™	S	√				√	
Holland Premier™	SM	√	√			√	
Hollandstone™	S	√	√			√	
Il Campo®	B	√	√			√	
LaRoca™	DW	√	√			√	

SYSTEM	FINISH	POSSIBLE APPLICATIONS					
		PEDESTRIAN	RESIDENTIAL VEHICULAR	INDUSTRIAL VEHICULAR	ENVIROMENTAL	PAVER QUILTING	CIRCLES & FANS
Mirada™	DW	√	√			√	
New England Cobble™	S	√	√				
Olde Greenwich Cobble®	D	√	√			√	
Olde Village Paver®	S	√	√				√
Optika®	S&WS	√	√				
Optiloc®	S			√			
Promenade™	SM	√	√			√	
Richcliff™	F	√					
Series 3000®	WS	√	√			√	
Stonehenge™	DW	√	√			√	
Symetry™	S	√	√				
Turfstone™	S		√		√		
Tumbled Camelot™	W	√	√				
Tumbled Holland™	W	√	√				
Uni Eco-Stone®	S			√	√		
Uni-Decor®	S	√	√				
Unigranite®	SP	√	√			√	
Uni-Stone®	S	√	√	√			
Yorkstone™	F	√					

Finishes: B=Brushed; C=Cobblestone; D=Dimpled; DW=Dimpled and Weathered; F=Flagstone; S=Standard; SP=Split; SP/W=Split and Weathered; T=Timeworn; W=Weathered; WS=Washed

Note: This application chart should only be used as a guide. Site conditions, base materials, pattern, and frequency of use may vary the performance of various types and styles of products. Products are subject to regional availability. Check for product availability at your Unilock® location.

Concept

All Unilock® retaining wall systems have been engineered to work on the basic premise that the mass of the concrete units will counter the force of the soils being retained. To achieve this, units are simply stacked on top of each other using a runner bond pattern. The locking mechanism on each of the units interlocks with the units below. This creates a strong connection between the individual units, preventing sliding and bulging of the wall.

Most Unilock® retaining wall systems have a patented offset tongue-and-groove design, which ensures that each course is installed at the appropriate setback, further increasing the wall's stability. When the wall has been assembled, the retaining wall system remains flexible. This allows the wall to endure minimal settlement, deflection and freeze/thaw movement.

For the construction of walls less than 36" (1 m) in height, where good soil conditions exist, the typical installation method described in this guide should be used. When walls exceed this height, consult your local planning department and obtain professional engineering services.

Advantages

Unilock® retaining wall systems offer a great variety of advantages over all other types of retaining wall products.

- *Modularity* - These walls are flexible, yet retain their structural characteristics. Unilock® retaining wall units are easy to use and are dry stacking (no mortar required). They do not require special concrete footings to be installed. These multi-component systems allow for complete flexibility in design and ease of installation.
- *Freeze-Thaw Resistance* - These walls can absorb minor movements due to frost or settlement.
- *Aesthetic* - The visual impact of our retaining walls add character and charm to any project. With Unilock® retaining walls, color, shape and texture can be incorporated to complement the landscape design.
- *Components* - Many components are included with Unilock® retaining walls. With these, it is easy to save time during installation and create a uniform finished look for the wall.
- *Maintenance* - With proper installation, walls require virtually no maintenance.
- *Trouble-free Base* - A compacted granular base is all that is required. This reduces cost by not requiring an expensive structural footing.
- *Mechanical Installation* - Some Unilock® wall systems can be mechanically installed, reducing installation time and labor required.

Components

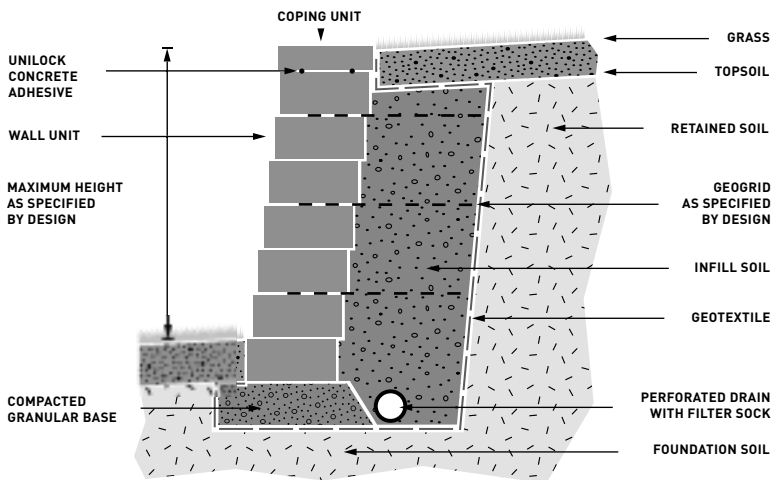

Figure 5. Typical components of a segmental retaining wall

Classification of Segmental Retaining Walls

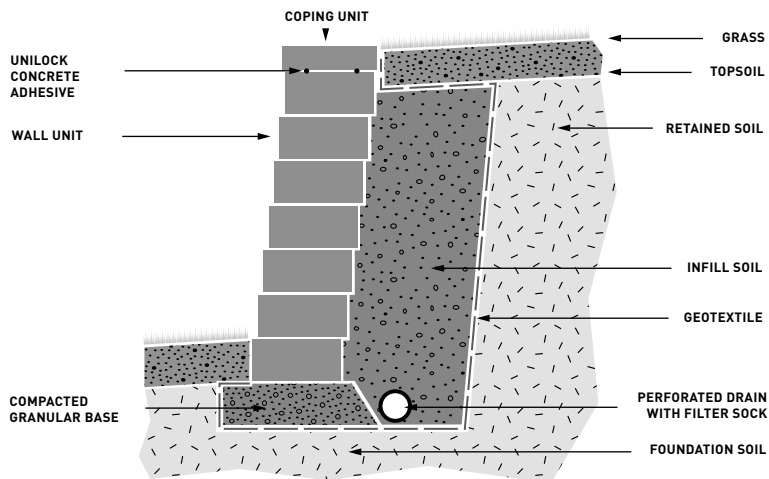

Figure 6. Conventional gravity structure

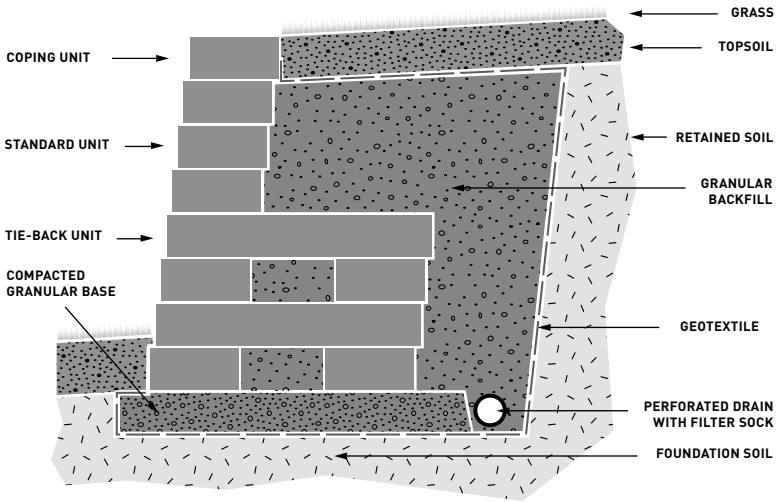

Figure 7. Crib structure

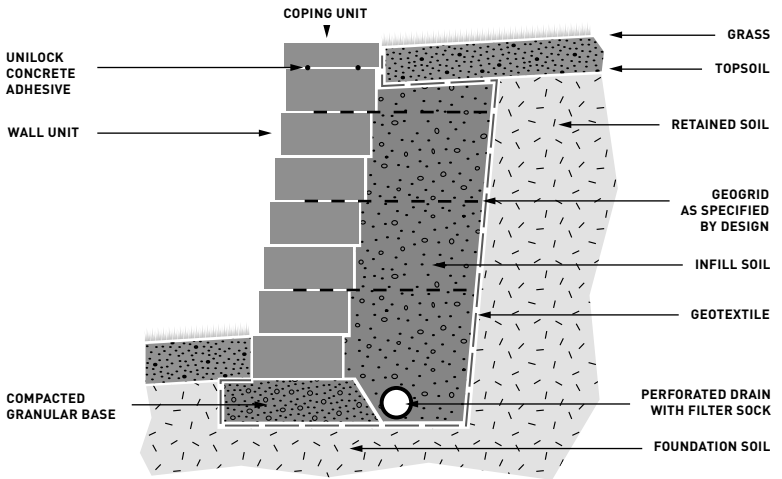

Figure 8. Reinforced structure

Retaining wall selection chart

Table 2: Unilock® walls selection chart

SYSTEM	FINISH	LOCK MECHANISM	TYPE			POSSIBLE APPLICATIONS							
			GRAVITY	REINFORCE(GRID)	CRIB (TIEBACKS)	MECHANICAL INSTALL	HEAVY DUTY WALLS	CURVED WALLS	SEAT WALLS	TERRACED WALLS	STEPS	EDGING	PILLARS
Brussels Dimensional Stone®	W	CA	√						√		√	√	√
Concord Wall®	SP	TG	√	√				√		√	√	√	√
Dura-Hold®	S	TG	√	√	√	√	√	√		√			
Dura-Hold2®	S	TG	√	√	√	√	√			√			
Estate Wall™	SP/W	PN	√					√	√	√	√	√	√
Olde Quarry™	W	PN	√	√				√	√	√	√	√	√
Pisa Reversible®	SP	TG	√						√	√	√	√	
Pisa Stone®	SP	TG	√	√					√	√	√	√	
Pisa2®	SP	TG	√	√				√	√	√	√	√	√
Roman Pisa®	SP/W	TG	√	√				√		√	√		√
Roman Stack®	SP/W	TG	√					√					
Roman Wall®	SP/W	TG	√	√				√			√		√
Siena Stone®	SP	TG	√	√		√	√		√	√	√		
Slope Block Mark IV®	SP	TG	√				√						
Sonoma Stone™	SP	TG	√	√		√	√	√		√	√	√	
Split'n Stack®	SP	TG	√					√					
Stack Stone®	SP	TG	√					√					

Finishes: S=Standard; SP=Split; SP/W=Split and Weathered; W=Weathered
 Locking Mechanism: TG=Tongue and Groove; PN=Plastic Pins; CA=Concrete Adhesive

Note: This application chart should only be used as a guide. Site conditions, base materials, loads and type of use may vary the performance of various types of systems. A qualified engineer must determine the suitability of the design, confirm site conditions and monitor the installation in critical applications. Products are subject to regional availability. Check for product availability at your Unilock® location.

Sketch or plan

A well thought-out design, combined with proper planning, makes the installation proceed smoothly and ensures a quality installation. Proper planning and organization will reduce headaches and costly mistakes and will improve customer relations.

It is recommended to elaborate on a plan, showing all measurements, diagrams and cross sections for all landscape elements. Elevation views and all details involved in the project should be sketched as well.

Engineering design and certification

Walls greater than 3' (1 m) or with a heavy load must be engineered by a qualified engineer. Some municipalities require even lower heights, such as 2' (600 mm), to be designed by an engineer. Fencing or railing may also be required. Verify local codes.

Only "stamped" drawings should be installed. A retaining wall is an engineered structure and must be installed as per engineering guidelines. Failure to install it properly could result in wall failure, leading to property damage or personal injury. A failed installation is very expensive to remedy.

The presence of slopes greater than 3:1 or other weights, such as vehicular traffic above a wall, can adversely affect the wall's performance. This needs to be identified for appropriate engineering.

Flow of materials

Moving material onto the site and balancing the flow of material before the job begins are important to complete the job without delays. Planning the movement and timing of materials also affects the productivity of the crew.

Consider where all materials need to be dumped or placed. Allow space on the site for their delivery. Avoid placing material away from the project area and hauling them in small quantities to the different areas. This wastes time. (Figure 9)

Efficient handling of the pavers will affect the length of time taken to complete the balance of the job. It is recommended to use a forklift or a paver cart so it is possible to move a whole section of pavers at once. This tool will reduce labor costs and can pay for itself in a single job.

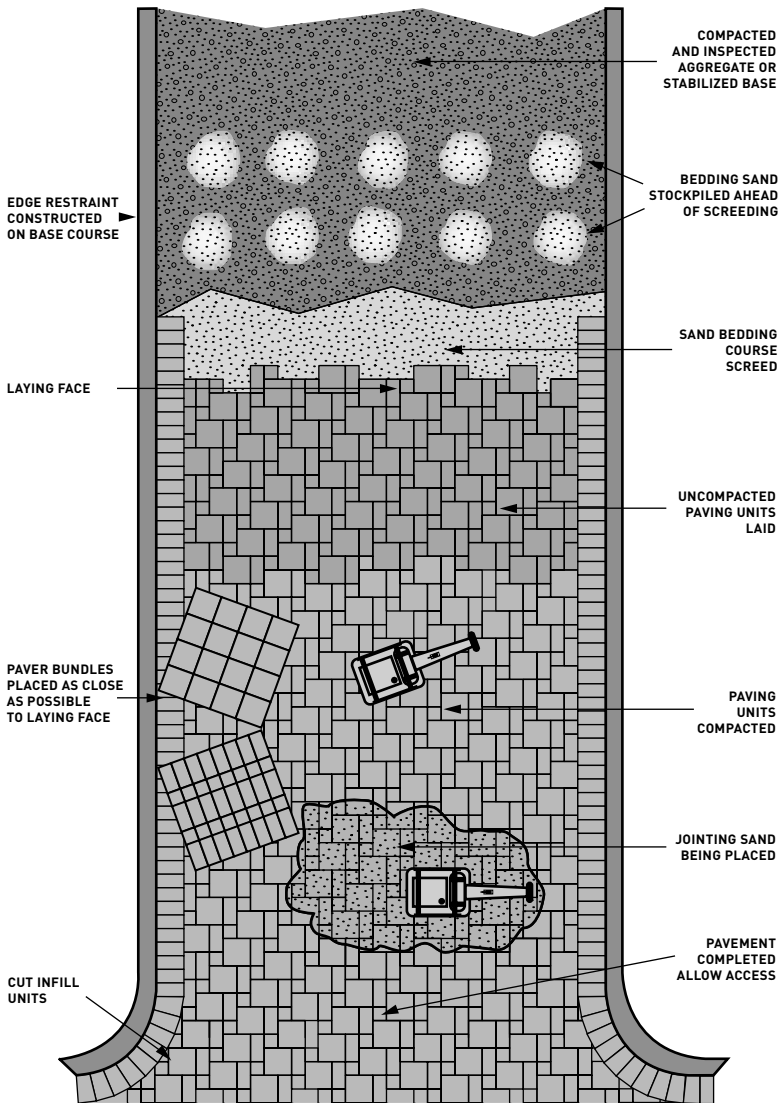

Figure 9. Flow of material onto the job site

Utilities location

For personal safety of all crew members, make sure that all underground utilities have been located and clearly marked. Contact local utility companies to find any underground services, such as telephone, electricity, gas, cable TV, etc. Mark any structures, such as water supply, irrigation piping, storm and sanitary sewer, etc.

Base Construction

Layout for excavation

Stake out the area - Before excavation begins, mark out the perimeter with paint, locating all elements, such as steps, planters, raised patios, etc., in order to get a "feel" for the design. This will make it easier for the crew working on the job to understand the scope of the project. Set measurements and stakes with another crew member as a "double-check". (Figure 10) Changes sometimes need to be made from the original plan due to certain site issues that were not addressed in the original design.

The perimeter of the paver and wall installation should be at least 8" (200 mm) greater than the actual area to be constructed. Mark the elevations on stakes with string lines so that the depth of excavation can be checked as it progresses. Using a nylon mason's line set the finished elevation of the pavement. Measure all excavations and base thickness from these lines. Check the initial elevations at the beginning of each day.

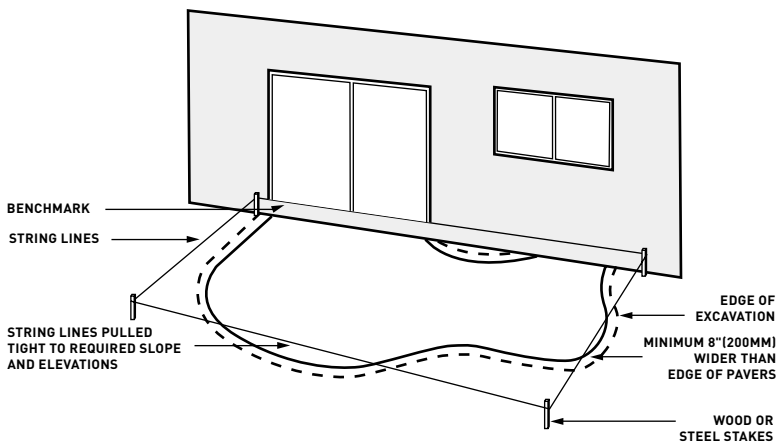

Figure 10. Project layout and staking

Excavation

There are several factors associated with base construction that may impact the depth requirements of the base. The depth of excavation depends on load requirements, drainage, existing soil conditions and paver or wall style and thickness. To determine the depth of the excavation, use of the following tables is recommended.

Table 3: Typical base thicknesses for pavers

PAVERS	WELL DRAINED AREA / UNDISTURBED SOIL		POORLY DRAINED AREA / DISTURBED SOIL		PAVER THICKNESS
	GRANULAR BASE	BEDDING COURSE	GRANULAR BASE	BEDDING COURSE	
Pedestrian Traffic Patios, Walkways, Pool Decks	4" (100 mm)	1" (25 mm)	6" (150 mm)	1" (25 mm)	2 3/8" (60 mm) 2 3/4" (70 mm)
Vehicular Traffic Residential Driveways	8" (200 mm)	1" (25 mm)	12" (300 mm)	1" (25 mm)	2 3/8" (60 mm) 2 3/4" (70 mm) 3 1/8" (80 mm)
Vehicular Traffic Commercial Areas	12" (300 mm)	1" (25 mm)	18" (450 mm)	1" (25 mm)	2 3/4" (70 mm) 3 1/8" (80 mm)
Total Excavation = Granular Base + Bedding Course + Paver Thickness - 1/2" (13 mm) for an uncompacted bedding thickness					

Table 4: Typical base thicknesses for walls

WALLS	GRANULAR BASE	UNIT THICKNESS BELOW GRADE	GRANULAR BACKFILL WIDTH
Steps, Planters, Raised Patio Height less than 18" (45 cm)	Min. 4" (100 cm)	Min. 3" (75 mm)	Min. 8" (200 mm) - 12" (300 mm)
Steps, Planters, Raised Patio Height greater than 18" (45 cm)	Min. 6" (150 cm)	Min. 6" (150 mm)	Min. 12" (300 mm) - 18" (450 mm)
Special Applications Pillars, Fountains, Water Features	Min. 6" (150 cm)	Min. 6" (150 mm)	N/A
Retaining Wall Applications	Min. 6" (150 cm)	Min. 6" (150 mm)	Min. 18" (450 mm)
Total Excavation = Granular Base + Unit Thickness Below Grade			

Table 4 is based on well-drained and undisturbed soils. The granular backfill depends on type of soil, drainage conditions, height and type of wall (gravity, reinforced or crib)

Soil conditions

When working in areas where there are poor soil conditions (e.g. heavy clay, disturbed soils), there is the potential for surface deformation or settlement. Action must be taken to increase the depth of the base to provide more stability. Always remove any loose or disturbed soils.

Here are some quick field tests that can provide hints on the type of soil in the job site.

Quick field soil identification - Using simple field tests like the "patty", "shake" and "snake" tests, a good idea of the basic soil type can be obtained. For each test, take a soil sample and add enough water to make it into a "putty type" consistency. Form the soil into a ball about the size of an egg. This is easily done for most clay and silt soils. Forming sandy soils may not be possible and may not be necessary since its gritty texture indicates its classification.

For the patty test, flatten out a sample about 3/8" (10 mm) thick and let it dry in the sun. After it is dry, it will either break easily or be more difficult to break. If it is difficult to break, it has high clay content. If it breaks easily, it has a predominance of sand and silt in it.

For the shake test, cup the ball of soil in two hands and shake vigorously for about 30 seconds. If small drops of water are released to the surface and hands, there is some sand in the soil. If no water is released, the soil is clay or contains some silt.

The snake test is done with clay or silt soils to determine how much water they will hold. This is seen by rolling the sample into a few moistened "snakes" about 3/8" (10 mm) in diameter. If snakes can be made greater than 2" (50 mm) long, the soil has potential to hold much water (high plasticity soil). If the snake falls apart before it rolls into a 2" length, the soil is consider low plasticity and will drain water.

Site drainage

All lines and final elevations of the pavement should slope away from the house or building. The minimum recommended slope is 2% or 1/4" per every foot of pavement (20 mm per meter) as this will better facilitate drainage. (Figure 11) The maximum slope for comfortable walking is 7 degrees or about 12%. Note: 8% is the steepest slope for pedestrian accessibility. Anything greater than 3% is considered to be a slope.

Grading of the base material is often done with a large landscape rake guided by several string lines. Larger areas may require the use of a transit (surveyor's level) to accomplish more delicate grades.

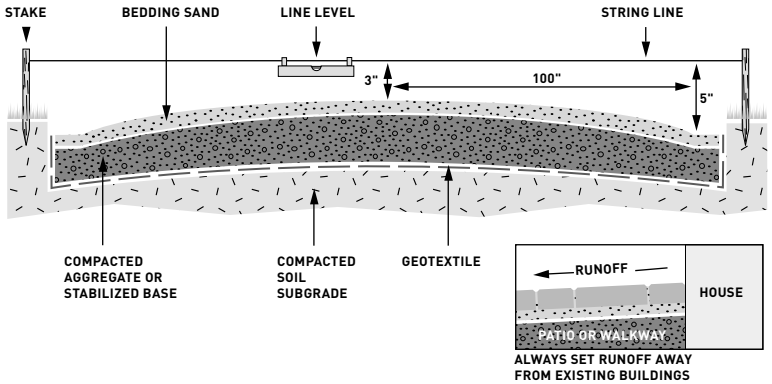

Figure 11. 2% is the minimum recommended slope for site drainage.

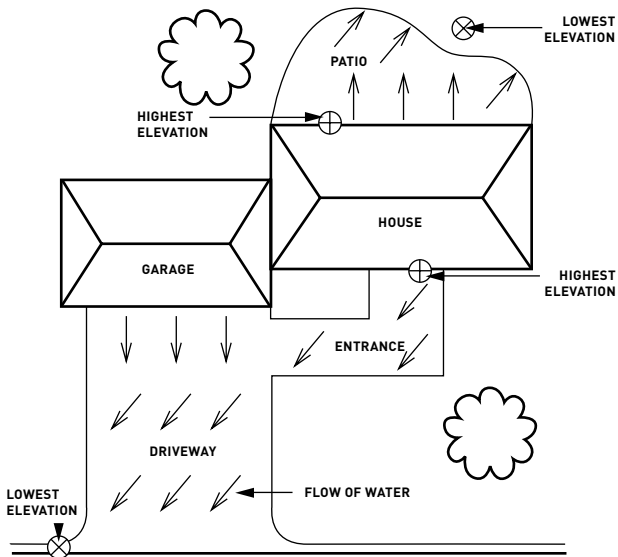
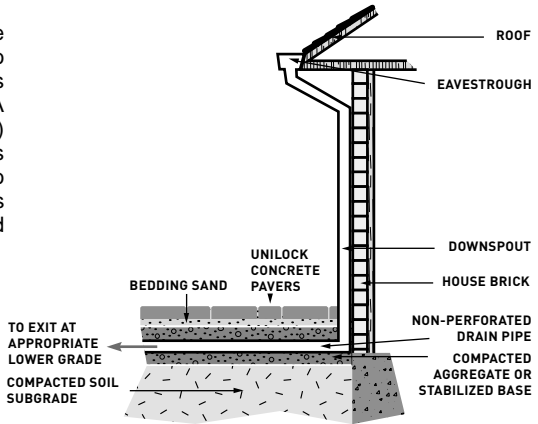

Figure 12. Runoff should always be directed to the lowest elevation.

Downspouts - Rerouting downspouts (Figure 13) so that the roof water is diverted away from paved areas is an inexpensive insurance for protecting the integrity of the installation and it is easy to do early on in the project. The trenches may need to be excavated manually so a proper slope can be put on the pipe.

Drain pipes should be surrounded by gravel so the area remains as frost-free as possible. A minimum of 3" (75 mm) of gravel should always surround the pipe. To avoid settlement, always compact well trenched areas.

Figure 13.
Downspout



Soil compaction

Once an area has been excavated, the soils at the bottom must be compacted prior to the placement of the new base material. It is important to spend as much time as possible compacting to achieve good compaction. Insufficient compaction may result in settlement.

Compaction achieves four main purposes. It increases the load-bearing capacity of the soil, prevents settlement/rutting, reduces seasonal movement from moisture changes and freeze-thaw cycles and helps ensure that movement during freeze-thaw cycles is uniform.

Avoid compacting excessively wet or dry soils. Every soil has optimum moisture content. Higher or lower water content than optimum produces lower density during compaction. The optimum moisture content in relation to density of a soil is normally tested in a soil laboratory using the Standard Proctor Density (SPD) test.

Compaction moisture content field test - For non-commercial applications, the "drop" test is a simple soil moisture content field test. Prior to soil compaction, remove a sample from the newly excavated subgrade surface and press it into a tennis-ball-sized clump. Hold the ball about 2' (600 mm) above a flat rigid surface and drop it. If the sample breaks into at least three or four equal size particles, it is close to optimum moisture content and ready to compact. If it breaks into many small pieces, it is too dry and water may need to be applied to the soil prior to compacting. If the ball doesn't break at all, it is too wet and the soil will likely need to dry prior to compacting.

Right equipment - The best way to compact cohesive soils, such as clay and silt, is with a low amplitude vibratory roller or rammer (Table 5) as they effectively remove air and force the particles closer together. For very heavy clays, a minimum 5,000 lbf (21 kN) reversible plate rammer is recommended. Adding a thin layer of base material (1/2" - 10 mm) over stable but sticky clay can reduce compaction time.

Noncohesive soils, like sands and sandy gravels, compact best with vibratory plate compactors and vibratory rollers. It's recommended to use large plate compactors, at least 4,000 lbf or 18 kN, or a walk-behind vibratory roller. For larger jobs, a ride-on double drum roller compactor with 7,000 lbf to 9,000 lbf (30 to 40 kN) is suggested.

Soft spots - Sometimes during compaction, soft spots will become apparent, especially in heavy clay soils. In these cases, it will be necessary to remove the soil and replace it with suitable base material and compact it.

Table 5. Soil compaction equipment

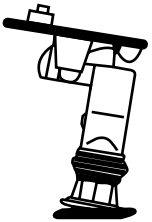
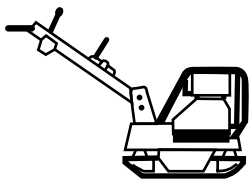
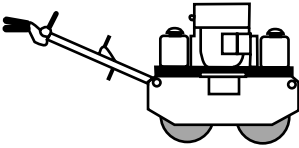
		
<p>Rammer (7,000 lbs)</p>	<p>Medium Compactor (4,000 lbs)</p>	<p>Large Compactor (5,000 lbs)</p>

Base installation

Geotextiles - Installation of geotextile (filter fabric) over cohesive soils, i.e. clays or silts, is highly recommended. It is also a good option for use over soils that stay saturated for a large portion of the year. The fabric separates the "fines" in soils from the granular base and prevents them from migrating upward into the base, resulting in reduced base performance.

Geotextiles do not typically increase the load-bearing capacity of a pavement or a retaining wall. Rather, they retain the intended load-bearing capacity. They can be considered inexpensive insurance for extending the life of a compacted base. They do not allow for a reduction of base thickness.

Installing geotextiles around the perimeter will also prevent migration of adjacent soils into the base material. Cover the sides with fabric and fasten it to the ground with metal staples while removing all wrinkles. Excess fabric and exposed staples can be removed once the job is completed. When installing geotextiles, it is important to overlap them in the direction of the grade by placing the fabric at the lowest elevation first, and working up to the higher elevation next.

Base installation - Like soils, the right amount of moisture in the base material ensures reaching maximum density during compaction. Most crushed aggregate bases require about 5% to 6% optimum moisture content to reach 100% Standard Proctor Density. If the aggregate is dry, spread and moisten by spraying before compacting, allowing the water to penetrate to the full depth of base thickness.

When the aggregate is not at its optimum moisture throughout the lift thickness, there is a risk of compacting only the top portion of the base. As a result, it will not compact to maximum density and pavement settlement may occur in the future. In contrast, adding excessive water can create pumping of the aggregate under compaction. This will lead to lower than desired densities. To easily check the moisture content of the aggregate in the field, grab a handful and squeeze it tightly for a few seconds. After opening the hand, a good sign of the right amount of moisture is that the aggregate is sticking together with no water draining.

When installing the first layer of aggregate, it is important not to compromise the integrity of the geotextile with wrinkles. Place the first aggregate lift ahead of the loader wheels, ensuring that the equipment does not drive directly over the geotextile. This also reduces the risk of tearing or puncturing the fabric.

Quality of base materials

Specifications typically used by cities, states or provinces for dense graded aggregate base materials under flexible asphalt pavements are generally adequate for pavers. These specifications can be obtained from engineering departments. If no specifications are available, then use the recommended grading for aggregate bases in accordance with ASTM D 2940. (Table 6)

Table 6: ASTM D 2940 - Standard Specification for Graded Aggregate Material for Bases or Subbases for Highways and Airports

SIEVE SIZE	PERCENT PASSING		JOB MIX TOLERANCE	
	BASES	SUBBASES	BASES	SUBBASES
2" (50 mm)	100	100	-2	-3
1 1/2" (37.5 mm)	95-100	90-100	±5	+5
3/4" (19 mm)	70-92		±8	
3/8" (9.5 mm)	50-70		±8	
No. 4 (4.75 mm)	35-55	30-60	±8	±10
No. 30 (600 µm)	12-55		±5	
No. 200 (75 µm)	0-8	0-12	±3	±5

Base thickness

The thickness of the base is determined by traffic loads, soil strength, subgrade soil drainage, moisture and climate. A qualified civil engineer familiar with local soils and traffic conditions should be consulted to determine the appropriate base thickness for streets, industrial pavements and critical retaining wall installations.

Minimum base thickness guidelines that apply to most areas in North America are shown in tables 3 and 4 (Page 13). Greater thicknesses for the listed applications are often used in regions with numerous freeze-thaw cycles, expansive soils or very cold climates.

Base compaction

Rake and grade the base to string lines so that the base will compact to a uniform thickness and to the planned slope. This can be done with the backside of a grading rake (sometimes called a "lute"). The rake helps prevent aggregate segregation of larger particles from smaller ones, which reduces the compacted density. Garden rakes are not appropriate for spreading base aggregates.

Individual base lifts (layers) should be installed in uniform thicknesses to prevent waste and help ensure uniform density. A thickness tolerance of $\frac{3}{4}$ " (19 mm) to $\frac{1}{2}$ " (13 mm) is recommended for the final base thickness. Too much aggregate wastes time and money. Too little aggregate can create a base with reduced support.

The total number of passes to accomplish full compaction to the required proctor density depends upon the weight and travel speed of the compactor. See Table 7 for guidelines regarding maximum lift loads and minimum number of passes. A good field indicator that full compaction has been reached is that your compactor will begin to bounce slightly as opposed to the regular vibration.

Table 7: Compaction equipment

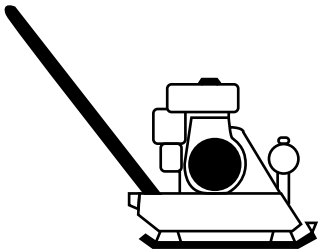
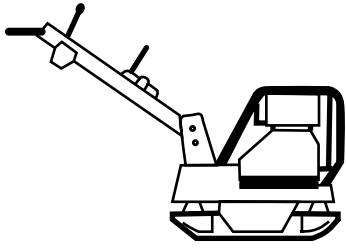
	
<p>Small Compactor (3,000 lbs) - 3" (75 mm) maximum lift thickness. Minimum 3 passes per layer.</p>	<p>Medium Compactor (4,000 lbs) - 4" (100 mm) maximum lift thickness. Minimum 2 passes per layer.</p>

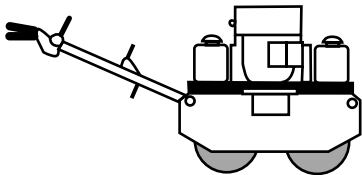

Large Compactor (5,000 lbs) -
6" (150 mm) maximum layer
thickness. Minimum 2 passes per
layer

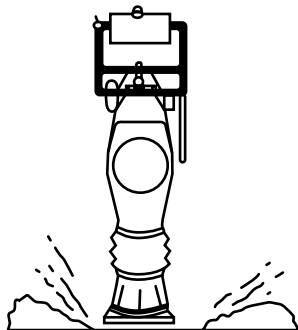

Rammer (7,000 lbs) - (Unconfined)
6" (150 mm) maximum lift
thickness. Minimum 2 passes per
layer.

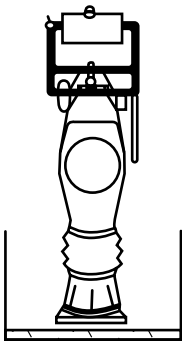

Rammer (7,000 lbs) - (Confined)
8" (200 mm) maximum lift
thickness. Minimum 2 passes per
layer.

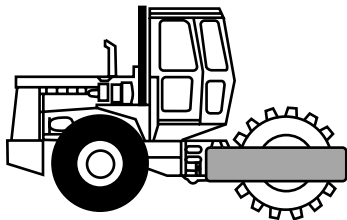

Vibratory Roller (9,000 lbs) -
8" (200 mm) maximum layer
thickness. Minimum 2 passes per
layer.

When compacting soils or base materials, compact first in one direction (Perimeter Compaction), then compact the entire area again with passes perpendicular to previous ones (Lateral Compaction). Overlap should be about one-third the width of the plate compactor base. (Figure 14)

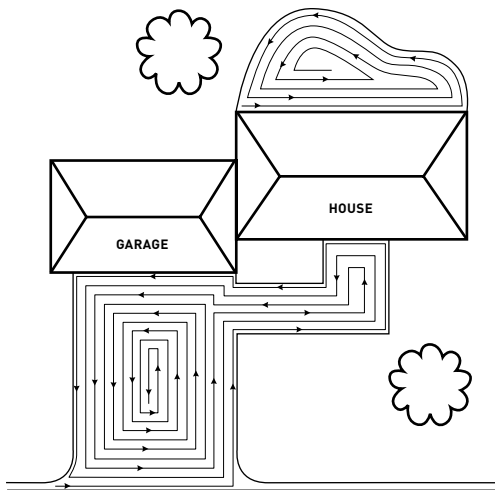

Perimeter Compaction

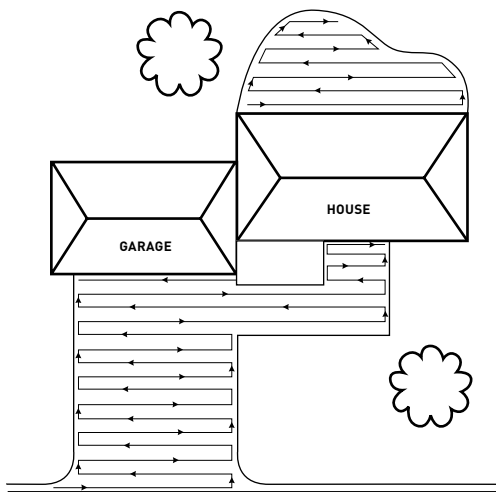

Lateral Compaction

Figure 14. Compaction directions.

There are some indicators that the point of nearly complete compaction is being reached:

- When the compactor starts "crabbing" (moving in a sideways motion)
- The "spike test" - where it takes at least a three pound (1.5 kg) hammer to drive an 8" or 10" (200 mm - 250 mm) long spike into the base.

Compaction Testing - For critical applications, base compaction should be tested on site by a qualified geo-technical technician with a nuclear density gauge. This compaction test device tests the Standard Proctor Density (SPD). It is a required test for most commercial projects. The minimum standard is 95% SPD.

After compaction, it is recommended to check all grades using a tape measure and some string lines. A simple way to check the final elevation of the compacted base is to run a grading rake under the string with a blade as thick as the compacted pavers and bedding sand (usually about 3" or 75 mm). This enables a quick visual check on the base height and slope as the rake is moved under the string. (Figure 15)

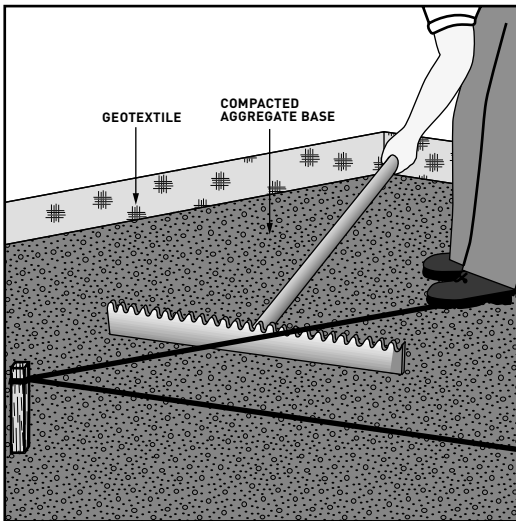

Figure 15. Use a grading rake for checking grades.

Rolling a steel pipe or moving an aluminum screed bar across the surface is useful to establish where there are any small depressions on the surface. Spray some paint on those spots and fill them with additional base material. A maximum base surface tolerance of 3/8" (10 mm) over 10' (3 m) is recommended. (Figure 16)

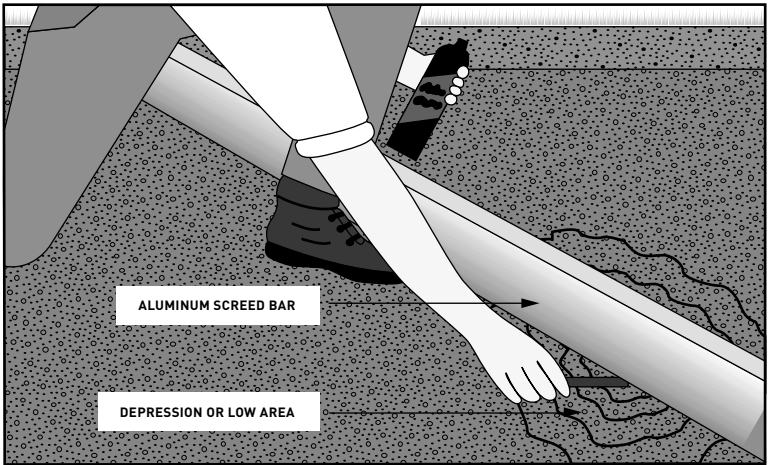

Figure 16. Check grades with a screed bar.

PAVER INSTALLATION

Edge Restraints

The purpose of installing an edge restraint is to prevent the horizontal movement of the pavers along the perimeter, maintaining the integrity of the pavement. There should always be an edge restraint installed along the entire perimeter or where there is a change in the pavement material, unless the pavers are being installed along a fixed edge, such as a building, a retaining wall, a curb or a planter. Restraints should also be selected, designed and installed to remain stationary under the occasional impact from wheels.

The base material should always extend beyond the restraint. A rule-of-thumb: the base should extend beyond the restraint by the same dimension as the thickness of the base material. For example, if the base is 8" (200 mm) thick, then it should extend at least 8" (200 mm) beyond the outside edge of the restraint. This contributes stability to the restraint and the pavement edge, especially in soils subject to frost heave. Soil backfill is never a suitable edge restraint, and edge restraints should never be installed on top of the bedding sand.

Positioning edge restraints - The correct positioning of edge restraints is very important. It will determine the accuracy of the joint lines relative to various structures. Paver joint lines should either be parallel or be perpendicular to the largest abutting structure. In the case of a house, pavers should be installed parallel or perpendicular to the garage floor or main entrance.

There are two possible methods of positioning edge restraints. Use an existing fixed edge and then run a string line along the edge, sighting it at a further point, ensuring that it is relatively straight. The second method is to calculate an exact 90-degree line from a fixed edge. (Figure 17)

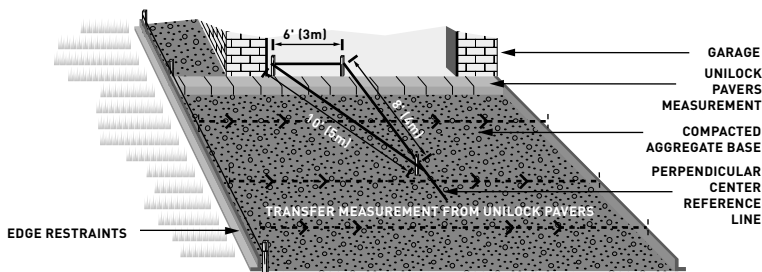

Figure 17. Edge restraint positioning.

Types and applications - Table 8 shows the types of edge restraints and their application. There are several types of edge restraints: Precast concrete, plastic, cut stone, aluminum, segmental walls and poured-in-place concrete.

Table 8. Application guide for edge restraints

APPLICATION	PRECAST CONCRETE & CUT STONE	ALUMINUM	PLASTIC	WALLS & POURED CONCRETE
Sidewalks - no vehicular traffic	√	√	√	√
Plazas - no vehicular traffic	√	√	√	√
Residential driveways	√	√	√	√
Crosswalks on asphalt or concrete streets	√		√	
Commercial/Industrial driveways	√		√	√
Parking lots	√		√	√
Streets - all types	√			√
Utility covers	√			√
Industrial flooring				√
Trucking terminals				√

Edge restraint installation

Edge restraints can be installed prior to the laying of the pavers, or they can be installed after the pavers are laid. When they are installed before, they may be used to control the thickness of the bedding sand when it is screeded. Special attention should be given to the elevation of the pavers next to the restraints. Pavers require a finish elevation (after second compaction) of 1/4" (6 mm) above the top of the restraint. This allows for minor settlement of the pavers and surface drainage. It further minimizes potential tripping due to excessive wear on the restraining material.

When restraints are installed after the pavers and bedding sand, the area of pavers is extended past the planned edge location. Then, the pavers are marked with a chalk line, plastic pipe or by using the edge material itself as a large ruler for marking. The marked pavers are then cut with a powered saw. The unused ends and excess bedding sand are removed up to the cut pavers, and the soldier course and edge restraints are installed. (Figure 26, Page 33)

For heavy vehicular traffic areas, when pavers are abutting another pavement, they should be placed against a concrete beam. (Figure 18) The beam prevents horizontal creep of the pavers due to braking and turning tires.

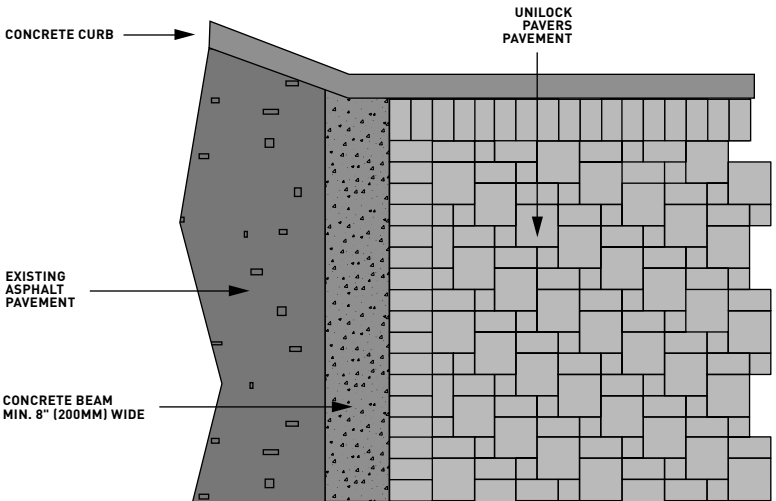

Figure 18. Concrete curb for heavy vehicular traffic areas.

After the edge restraints have been established, the final bed for the pavers to sit on must be prepared. This requires leveling the bedding sand to a 1" (25 mm) depth.

Bedding Sand - The material recommended for the bedding course is coarse sand (concrete sand). Other materials such as limestone screenings, mason's sand or slag are not recommended because they do not have the characteristics required. They have an excess of fine particles that will slow the drainage of water from the bedding sand, lubricate it and cause it to run and settle unevenly.

Sand gradation should conform to the requirements shown in Table 9. These are the specifications for course multi-grained sands. Check the sieve analysis periodically for sand delivered to the site through a local materials testing lab. Sometimes the quarry, or supplier of the sand, will supply this analysis. Check it before accepting the sand on the site.

Table 9. Gradation for Bedding Sand

SIEVE SIZE	PERCENT PASSING
3/8" (9.5 mm)	100
No. 4 (4.75 mm)	95 to 100
No. 8 (2.36 mm)	85 to 100
No. 16 (1.18 mm)	50 to 85
No. 30 (0.600 mm)	25 to 60
No. 50 (0.300 mm)	10 to 30
No. 100 (0.150 mm)	2 to 10
No. 200 (0.075 mm)	0 to 1

Bedding course installation

The evenness of the base surface should be checked with a straight edge before placing the bedding sand. Sand should not be used to fill depressions in the base. The filled depressions will be reflected on the surface of the pavers within a few weeks or months, creating a washboard appearance.

Screeding guides - Using a screeding is the process of leveling the bedding sand. This is typically done using a 1" to 1½" (25-40 mm) diameter or 1" to 1½" square pipe or bar set on the compacted base. Using the top rail of chain-link fencing or heavy-wall electrical conduit works well as a guide for screeding because they can be joined to cover large areas.

To establish the exact level of the screeding guides, as shown in Figure 19, hold a concrete paver on the pipe. Adjust the height of the pipe until the top of the paver extends above the string line or an existing fixed edge by 1/2" (13 mm). Be sure to maintain a consistent thickness of bedding sand. Do not compensate for depressions in the base by adding more sand. Instead, add and compact more base material.

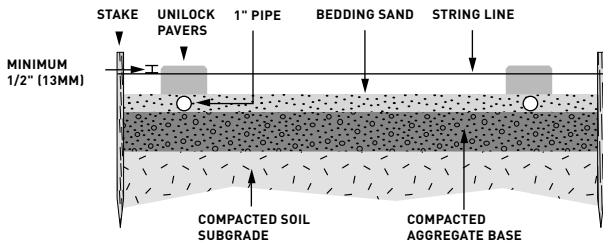

Figure 19. Set screeding guides.

Once the screeding guides are placed, coarse sand can be placed between them and roughly raked over the area to be screeded. Drag a board over the guides to make a smooth surface. Always make sure that there is enough sand in front of the screed board. (Figure 20) Two people can easily screed a section 8' to 10' wide. One person can screed an area 4' to 6' wide.

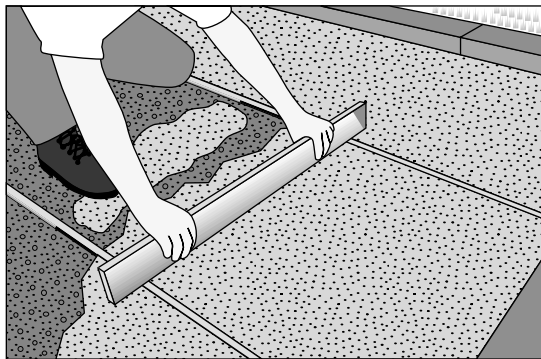

Figure 20. Screed bedding sand on screed bars.

Mechanical screeds save time and reduce fatigue because they are pulled by a small loader. These screeds can increase productivity of the operation by three to four times. The screed rails are set on the base and checked with a transit level or string line. The height of each end of the screed can be adjusted to accurately obtain the correct depth of bedding sand.

The next step is the installation of the pavers. This stage should proceed quickly and smoothly. Before opening the bundles, make sure you have read the bundle tag and that the correct quantity of product and the correct color is on site.

Color blending - When removing the pavers from the bundle, select pavers simultaneously from more than one bundle in a vertical fashion to mix the color efficiently over the entire installation. This applies to solid and blended colors.

Efficiency - Efficient handling of the pavers will affect the length of time taken to complete the job. Even though using a wheelbarrow or dolly to move pavers is a common practice, it is much easier to move the pavers with paver carts. (Figure 21) Products that are packaged in sections allow them to be used to "peel" off stacks of pavers from the bundles (usually 7-10 pavers high) at once. This tool will significantly increase the efficiency of the installation process.

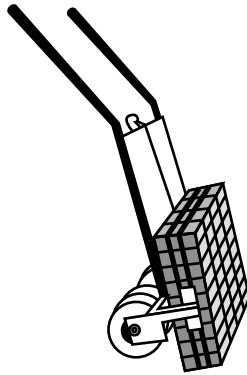

Figure 21. Paver cart used to bring pavers to laying face.

Laying patterns - Unilock® products can be laid in a wide variety of laying patterns and combinations. More than 185 paver hatch patterns are available at www.unilock.com. All patterns are grouped by system with several different patterns for each system included.

The shape of the pavers determines the range of laying patterns. Any pattern is suitable for pedestrian applications, like walkways, patios or pool decks. Running bond patterns can be used for residential driveways. It's important to always face the long lines perpendicular to the main traffic direction. Herringbone and random patterns are recommended in areas subject to continual vehicular traffic. They will give the maximum interlock and structural performance.

Manual installation

When installing the pavers, it is important to maintain consistent joint widths. Tight joints, with sand in them, will spread loads better than wide ones. Consistent joint widths also give a neat and orderly visual appearance.

When installing the pavers, do not slide them across the sand, but down the side of the previously installed unit. A build-up of sand between pavers will cause the alignment to go askew. Some pavers have spacers built into the unit that assist in maintaining the required $\frac{1}{8}$ " (3 mm) gap between each paver.

Starting the first few rows requires attention to the order of placing the units. This establishes the rhythm and pattern for the remaining courses. Begin laying the pavers leading off from right-angle corner to minimize any required cutting. Crooked lines are not visually appealing, therefore always run string lines or snap chalk lines on the screeded sand in several directions every 3' to 5' (1 to 1.5 m) to ensure that the pavers are all in alignment. Use a screwdriver to adjust their position, if required.

Starting from the middle of the pavement is the most recommended option. (Figure 22) This is done for several reasons. First, pavers may flow onto the site faster if paving begins at the center of the pavement, rather than from a corner location. Second, by starting at the center, a wider laying face is possible. A wider laying face allows more people to place pavers at the same time. Finally, starting at the middle of the pavement may be necessary because there may be no perpendicular corners from which to begin the laying patterns.

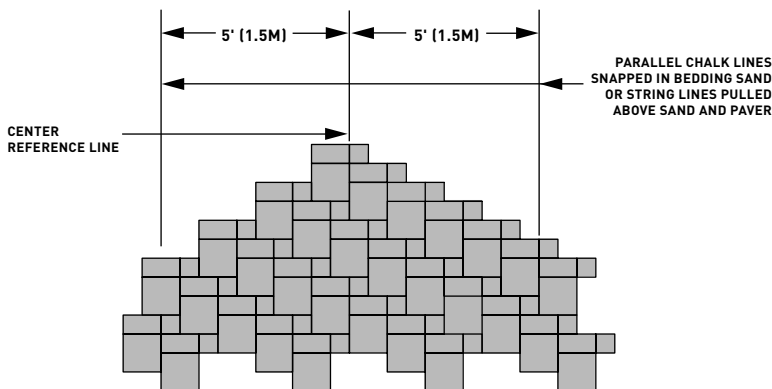

Figure 22. Parallel lines and center reference line.

Step-by-step manual paver installation

- If working with a fixed edge, install the soldier coursing first around the perimeter of the area. Then the body of the area can be installed.
- If there are any circles in the installation, they should be installed right after the soldier course. Then the body can be installed.
- Run string-lines on approximately 3' to 5' (1 m to 1.5 m) intervals in order to maintain straight lines. Snapping a chalk line on the screeded surface also works very well and cannot move accidentally.
- Lay the pavers in the desired pattern, making sure that color blends are installed evenly.
- Pavers should have approximately a 1/8" (3 mm) joint between pavers. Built in spacer bars on the sides of the pavers is standard on most Unilock® styles.
- Pavers that have just been laid may be walked on. Fill in any grooves left by the screed guides before laying the pavers. This can be done as you go.

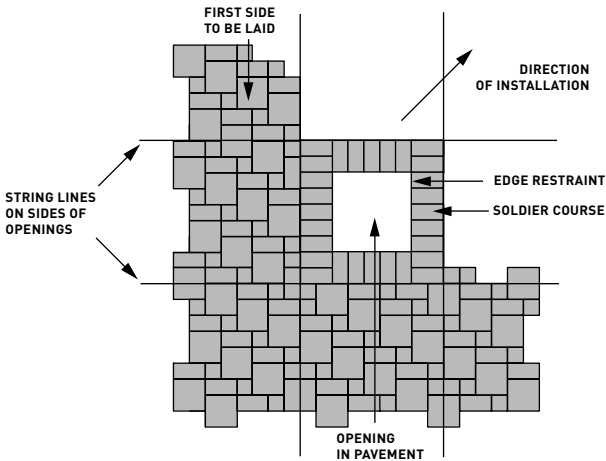

Figure 23. Paving around an opening or obstruction.

Openings or obstructions installation - For the installation of pavers around openings, like tree wells, man holes, planters and other landscape constructions, there must be an adequate edge restraint in place around the opening against which to place the pavers. This is typically plastic, steel, aluminum or concrete. (Figure 23)

First place a perpendicular string or snap chalk lines on all four sides of the opening. Then, place a border of full-sized pavers (soldier course) against the edge restraint. Next, lay pavers on one side, then the other. Count the courses needed to surround the opening on each side. After that, fill around the remaining side of the opening. Finally, cut pavers to fit and fill against the soldier course around the opening.

Mechanical installation

In order to reduce the labor intensity of hand placing pavers, and to increase the production rate, mechanical laying machines have been developed. They are generally equipped with a clamping system that can lift an entire layer of pavers from a pallet or cube and place them accurately on the bedding sand. This allows more than one square yard (one square meter) of pavers to be placed at one time.

A properly planned mechanical placement with a crew of four men can result in the placement of up 6,000 to 7,000 square feet (600 to 700 square meters) of pavers in an eight-hour working day. The use of mechanical equipment should be considered on any large project.

Shape, pattern, quality and color distribution are key considerations when deciding on pavers that are to be installed mechanically. For further information about this option, please contact your Unilock® Representative.

Cutting

Most jobs with concrete pavers involve cutting. Pavers are typically cut along the edge of the pavement, around planters or drainage inlets or when there is a change of pattern. Where pieces need to be cut, this is best achieved by marking out long sections at one time.

Begin cutting infill pavers as soon as the installation is far enough ahead to allow room for cutting, thereby reducing the potential for lateral movement. Small pieces (less than 1/3 of a paver) should be avoided as much as possible. However, if very small pieces are required, use a wet-cut table saw. Always wear hearing protection, protective glasses, gloves and a dust mask when cutting.

Cutting tools

- *Hammer & Chisel.* Least accurate method for cutting small paving stone pieces. Mostly used to split retaining wall units and certain styles of paving units.
- *Guillotine.* Cutting with a guillotine is fast and dust-free, but it is not as accurate and does not allow for very small pieces. Guillotines produce acceptable cuts for "tumbled" products, where precision is not as noticeable.

- *Power Saws (Diamond Blade or Abrasive Blade).* (Figure 24) They are very fast and provide precision cutting and excellent mobility. However, they are very dusty. They are normally gas powered, with engines similar to those used for chain saws.

Since dust can be a significant problem, it is recommended that you use a water attachment when cutting. Do not allow dust or spray to settle on cars, windows, flowers, shrubs, etc. Some contractors set up temporary cardboard or plywood walls to contain the spray. Some use vacuum equipment and a hose to collect dust right at the blade. A hand-held dry saw with a 12" (0.3 m) blade can cut about a 4' (1.2 m) radius.

- *Table Saws (Diamond Blade).* (Figure 25) They provide precision cutting, but lack mobility so can be time-consuming. Most saws can run either wet or dry. When water is used, it provides lubrication and reduces wear on the blade. If water is supplied to the saw, anticipating a nearby faucet in planning the job will save delays and money. If possible, use clean water and do not recirculate it as it will likely stain the pavers.

A by-product of cutting with a wet masonry saw is residue-filled water. This can stain pavers, so wash and remove the water from the pavers before it dries. Better still, cut in an area where drainage from the saw doesn't run on pavers or on nearby areas where there might be pedestrian or car traffic.

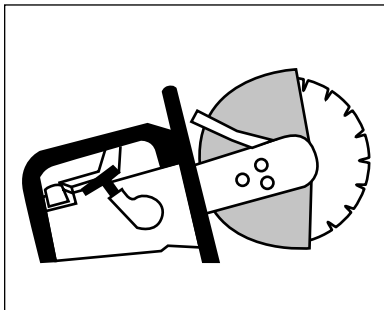

Figure 24. Cut-off saw

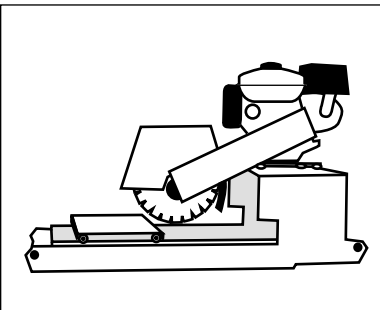

Figure 25. Table Saw

Marking Pavers for Cutting - There are basically two methods for marking pavers.

Method 1 (Figure 26) - The paver pattern is laid to the outer most edge, then a row of soldier course pavers is placed directly on top of the installed area in the same relative position that they will be in once the cuts are made. Then, using a chalk, marker or wax pencil, a mark is made along the edge of the soldier course or board. Cut the pavers and remove the pieces below. Place in the soldier course and the edge restraint for a perfect fit.

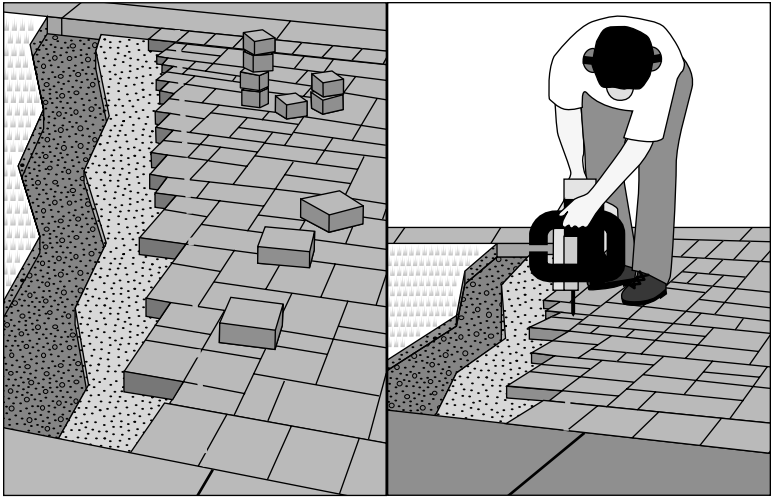

Figure 26. Marking and cutting pavers on site.

Method 2 (Figure 27) - First install the soldier course and then the field area up to the soldier course as close as possible. Hold a paver directly above the open space, then carefully mark the paver for cutting. This will require some practice to develop proficiency. After that, the paver can be cut on the table saw.

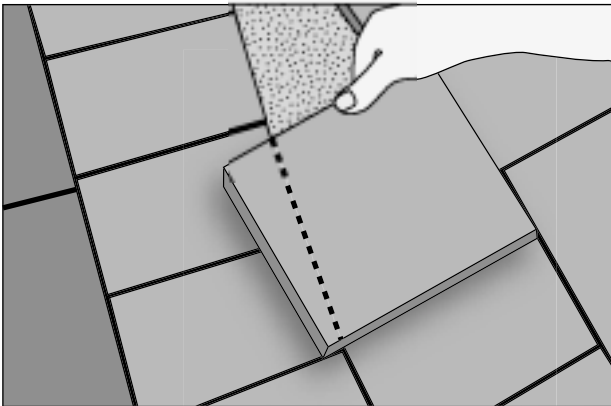

Figure 27. Marking pavers on site and cutting them on the table wet saw.

Compacting pavers

Compacting is very important for two reasons: First, it removes any slight height variations between the individual pavers, providing a smooth surface. Second and more importantly, it "sets" the pavers into the bedding course. Compacting forces sand from below up between the joints of pavers securing them from movement.

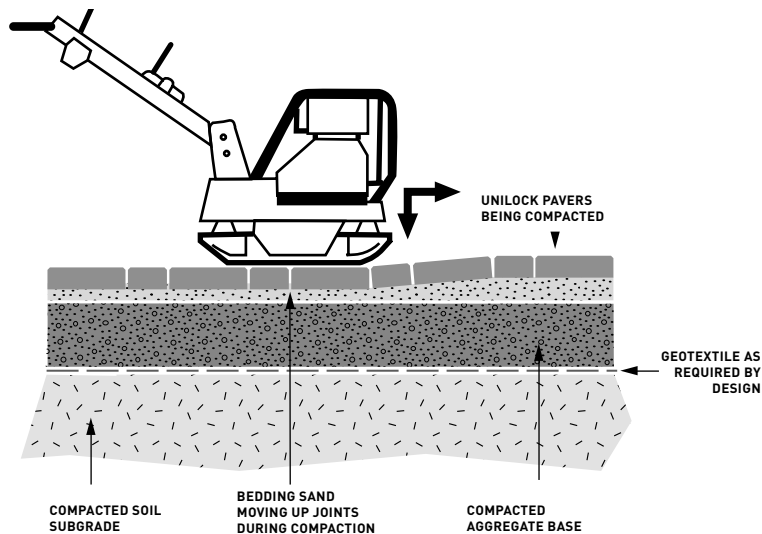
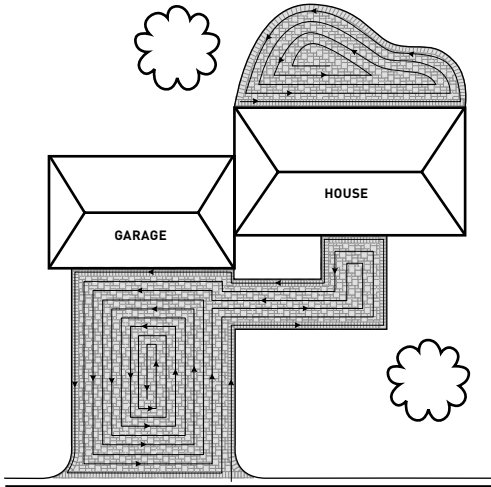

Figure 28. Pavers being compacted.

Compacting procedure - The surface must be free of debris or sand before compacting. (Figure 28) This will prevent scuffing on the face of pavers and make a smoother surface. A polyurethane pad bolted to the bottom of the plate compactor is ideal to prevent scuffing. This is particularly important when compacting textured pavers.

Run the compactor in parallel rows across the surface of the pavers, making sure you have compacted all pavers. Make two or three passes with the compactor in different directions. (Figure 29)

Thick paver units for heavily trafficked pavements [2¾" and 3⅛" (7 cm and 8 cm)] should be compacted with a minimum 5,000 lb (22 kN) force plate compactor. Lighter trafficked pavements typically use 2⅜" (6 cm) pavers, which are compacted with a 3,000 lb (13 kN) force plate compactor.



Perimeter Compaction

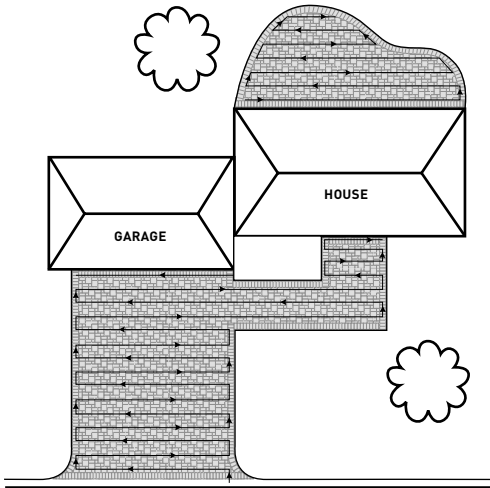

Lateral Compaction

Figure 29. Paver compaction directions.

Jointing sand

Sweeping sand into the joint of the pavers completes the interlocking effect, as it provides frictional resistance to vertical movement of individual stones. The sand also helps to distribute the load placed on the paved surface.

Before sweeping in jointing sand, the surface should be checked for any damaged stones that may have appeared from the initial compaction. A final color distribution check should also be made. These stones should be replaced before sand is swept in. After the sand is swept in, the pavers lock-up and it becomes more difficult to remove them.

Jointing Sand - Concrete sand can be used to fill the joints in pavers. This often requires extra effort due to large particle sizes. It is recommended to use Unilock® bagged jointing sand, which has the correct gradation and is very convenient to use because it fills joints faster. Unilock® Polymeric Joint Sand may be used as a replacement for ordinary jointing sand. This sand is a special mix of graded sand and binders formulated for achieving optimum lock-up of paving stones and discourages weed growth and the penetration of insects.

Installation - Spread a layer of jointing sand on the surface of the pavers and sweep it into the joints. (Figure 30) Use a stiff bristle push broom. Fill the joints and leave a thin layer of excess sand. Vehicle traffic should not drive on the paving surface before sweeping and second compaction has been completed.

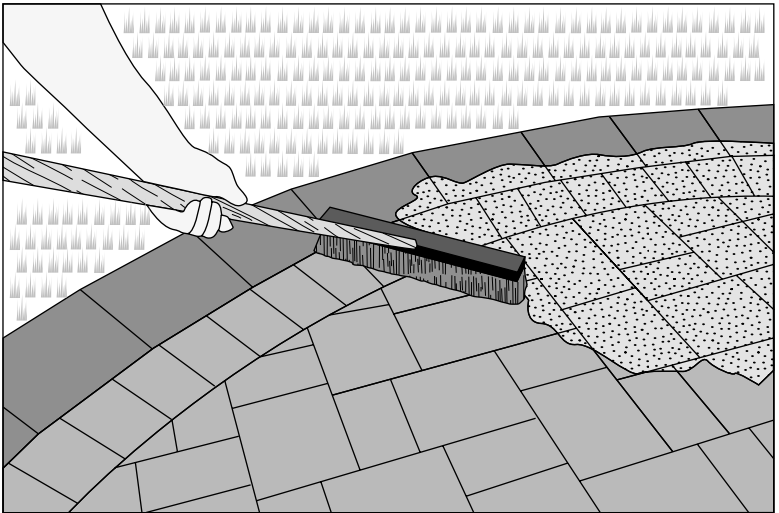

Figure 30. Jointing sand application.

Final compaction - After filling the joints, the pavers are compacted again using a plate compactor. This action will help settle the jointing sand into the joints and interlock the pavers. Follow the compaction pattern previously described in Figure 29. After compaction, the entire area should be swept again to ensure that the joints are filled with sand. A second pass with the compactor is recommended to assist in well penetration of the sand into the joints. Sweep the joints full and remove excess sand.

Cleaning and finishing

At the end of each day's work, all edge pieces must be cut and placed, all paver surfaces compacted, cracked or broken pavers replaced, joints filled with sand and the area compacted within 3' (1 m) of open unrestrained edges. Protecting the uncompacted, unrestrained edges with plastic or canvas during rainy weather is preferred to re-laying these areas after the storm.

As an alternative, after compaction and removal of excess sand, the surface may be cleaned and a liquid sealer or joint sand stabilizer may be applied to the pavement surface and joints. For more information on how to clean and seal paver pavements, refer to the Unilock® Maintenance Guide on page 55 or visit www.unilock.com.

GRAVITY RETAINING WALL INSTALLATION

Base preparation

The basic installation procedures for all Unilock® wall systems are very similar to each other. They are outlined below.

Grade changes - While preparing the base for walls and the grade changes, the excavation can be stepped so there is no need to bury more material than necessary. (Figure 31) The step-up height is always equal to the height of the wall unit being used. Stepping the grade properly will save time and eliminate needless digging and reduce the amount of wall units required.

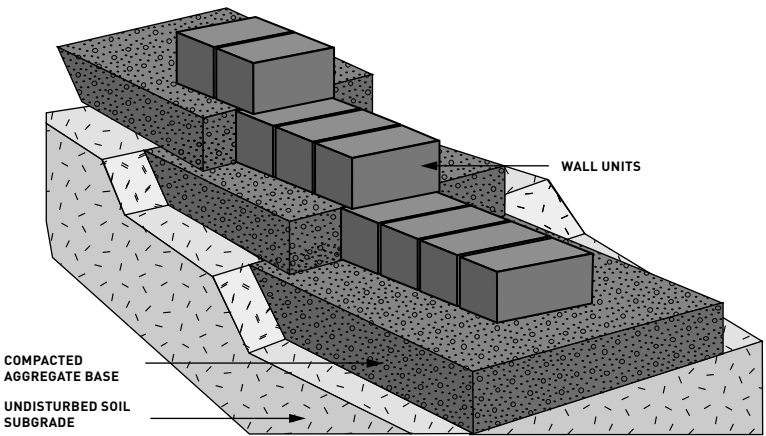

Figure 31. Stepped base for grade changes.

Filter cloth or geotextile - It is recommended that an approved filter fabric be placed between the existing soil subgrade and the new aggregate base. Plan for sufficient filter fabric to also separate the retained soils and/or clear crushed stone that later will be placed behind the wall.

Drain - Areas with greater than normal water runoff above or below grade will require different methods of directing the water away from the wall. A positive drain must be installed to alleviate any excessive water pressure that could affect the stability of a retaining wall. Outlets always must be planned prior to construction.

Drain placement options. - The drain may be outlet through the wall face or connected to a positive outlet (sewer). In the case of connecting to a positive outlet, the drain should be placed at the lowest possible elevation and sloped at a minimum of 2%. At the rear of the base, allow the granular material to slope down on the sides towards the drain trench. (Figure 32) In the area behind the base, place the approved drain tile (perforated drain with filter sock) on top of the filter cloth and minimal granular coverage.

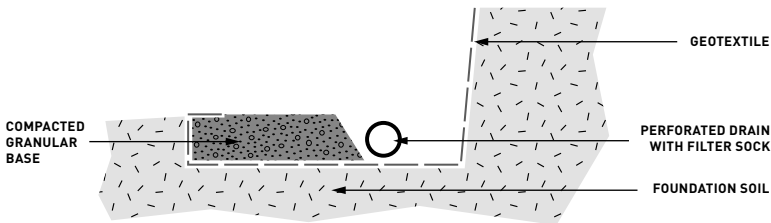

Figure 32. Drain tile placement.

Compaction -Compaction is the most important factor in constructing a stable retaining wall. It is critical that the existing ground remains undisturbed and that the added base material is compacted to 98% Standard Proctor Density. Although hand-tampers and power-tampers are both acceptable for compaction, power-compactors are strongly recommended for most projects. (Figure 33)

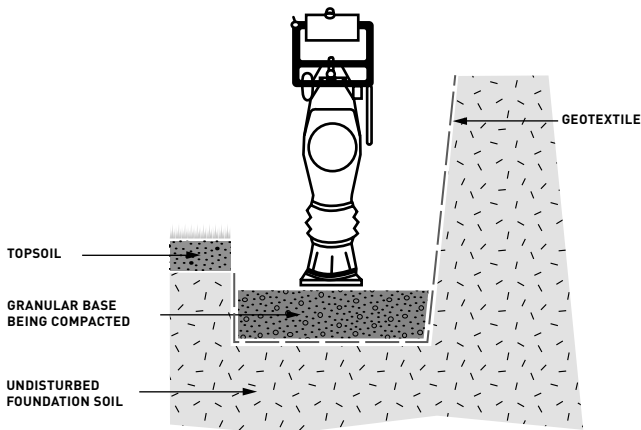

Figure 33. Base compaction.

Installing the first course

It is important to start construction at the lowest elevation of the wall. If the installation has corners, it is recommended to start at the corners first. The other place to start a wall is next to a fixed structure that the wall will end at (e.g. a basement foundation wall).

First course leveling - Position a level string line to mark the location of the first course. Then, the first course of units can be placed on the prepared base, making sure that the units are leveled front to back and left to right. Use the string line to keep the wall units straight and a standard carpenter level for leveling the individual units. Small amounts of coarse sand can be used to "fine-tune" the level of each unit. (Figure 34)

When positioning the first row of units, it is important to take into consideration the setback of the units, as well as the final height of the installation. Determining the position of the first stone will impact the final outcome of the job. For setback walls, each additional row added will reduce the width of the backfill zone.

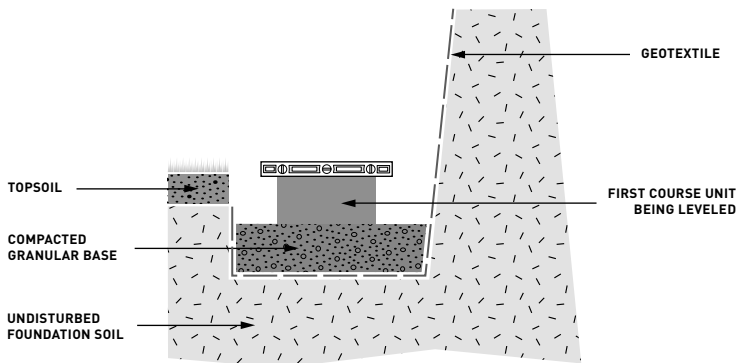

Figure 34. First course positioning and leveling.

Stack units

Sweep the top of the units to make sure there is no loose debris on the top of the blocks, preventing them from properly seating. Place the next course of units in a running bond pattern (offset $\frac{1}{2}$ unit) so that the middle of the unit is approximately above the joint between adjacent blocks below. This will require half units to be placed on alternating courses. When wall units have a built-in locking system, always slide them as far forward as possible to eliminate only slack in the channel.

Always get your wall units lined up near the actual wall so that the wall can be installed quickly. Stack only two or three courses at a time before backfilling. Continue stacking units until desired height is achieved. Some wall units need to be split before they are used. Having the material split and ready before installation begins will increase productivity. Always take into consideration the dispersion of the color distribution in color blends, when selecting the next unit to place.

Backfill

It is recommended that you backfill every 12" (300 mm) wall height. Proper backfilling is vital to the retaining wall's strength. Backfill must be placed behind the wall in maximum lifts of 6" (150 mm) and compacted to a minimum density of 95% SPD.

No heavy compaction equipment should be allowed within 3' (1 m) of the back of the wall. Only a hand-operated plate compactor can be used here. Over-compaction behind the wall facing will result in an outward rotation of the units and poor vertical alignment.

Coping unit

Some wall systems require coping units that cap the top of the wall. Once the wall units are in place, dry-fit all the coping units, then apply two beads of Unilock® Concrete Adhesive, ensuring both surfaces are free of debris. Place the coping units firmly on top of the adhesive and apply pressure to secure. Follow adhesive installation guidelines.

Some coping units have the option of being "rock-faced". This is achieved using a mallet and a masonry chisel, or by using a guillotine.

Finish grading

To encapsulate the granular backfill zone and finish grading, the filter cloth is pulled towards the wall and a 6" (150 mm) layer of topsoil is placed. (Figure 35) Slope the soil above and at the foot of the wall to ensure water will flow away from and not accumulate near the retaining wall. For other treatments, such as pavers, concrete or asphalt, care must be taken to ensure that heavy compaction or paving equipment remains a minimum of 36" (1 m) from the back of the coping unit.

Wall ends - If the retaining wall does not start or end at a building (or other structure), a "return" into the bank must be constructed. (Figure 36) Walls that follow the grade of a slope may not need a return as each course will either be built into the slope or follow the slope of the hill.

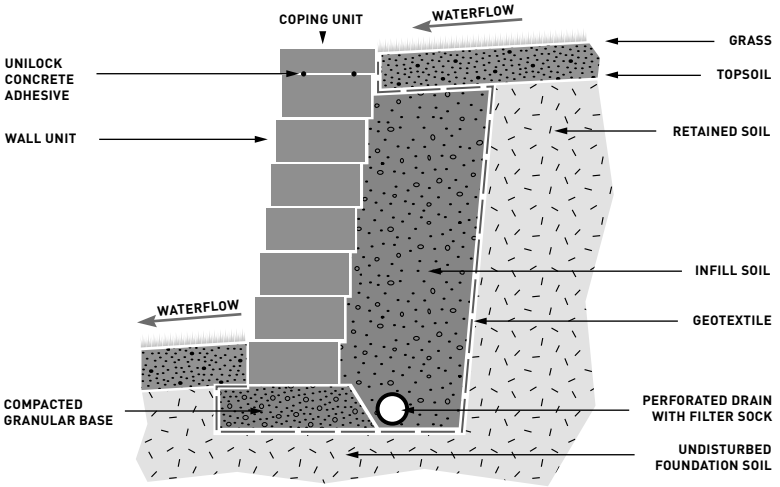

Figure 35. Encapsulate granular backfill and finish grading.

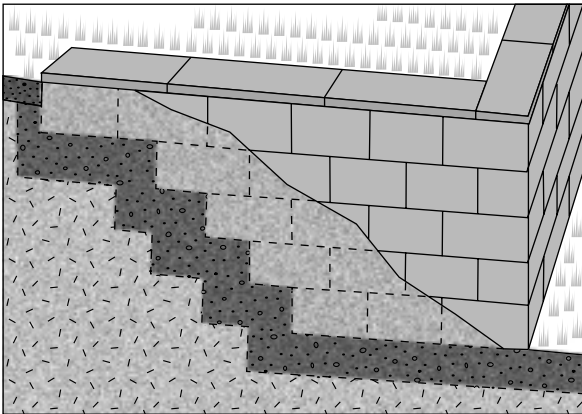

Figure 36. End of the wall should return into the bank.

REINFORCED RETAINING WALL INSTALLATION

Geogrid reinforcement

Geogrid reinforced wall construction is used to allow for the construction of walls beyond traditional gravity wall capabilities. When constructing these walls, additional steps should be followed.

Backfilling - Begin backfilling as described previously, up to the elevation of the first layer of geogrid reinforcement. (Figure 37) Caution must be taken to ensure the allowable lift thickness is not exceeded and/or heavy compaction equipment is not operated within 3' (1 m) of the back of the wall.

Ensure the geogrid reinforcement specified in the design matches the product on site. Cut the geogrid from the roll to the specified length, ensuring the geogrid is being cut perpendicular to the direction of primary strength. Ensuring the wall units are free of debris, lay the geogrid on top of the blocks to within 1" (25 mm) of the face. Place the next course of wall units to secure the geogrid in place. Pull the geogrid reinforcement taut across the infill material to its full length and stake in place to maintain tension. The backfill material should be level with the back of the wall unit, allowing the geogrid to be laid out horizontally.

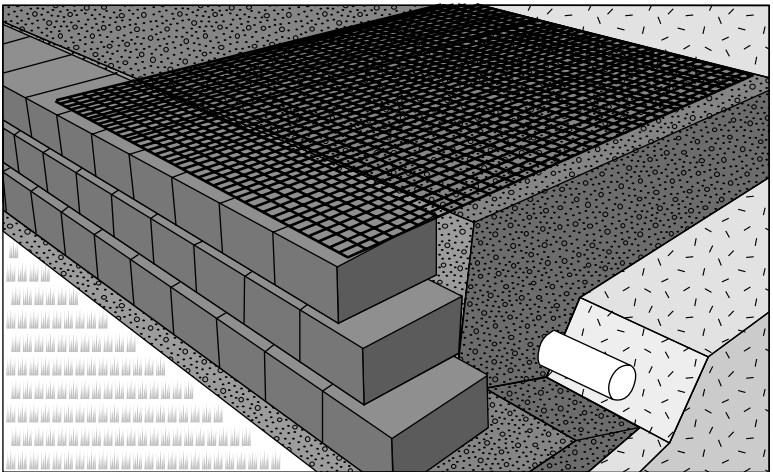

Figure 37. Geogrid reinforcement installation.

Backfill over geogrid

Backfill next lift of granular infill material on top of the geogrid reinforcement. Place the loose material at the front of the wall and rake it back away from the face. This method maintains tension in the geogrid during backfilling. Continue stacking units and backfilling until the next layer of geogrid reinforcement is reached. (Figure 38)

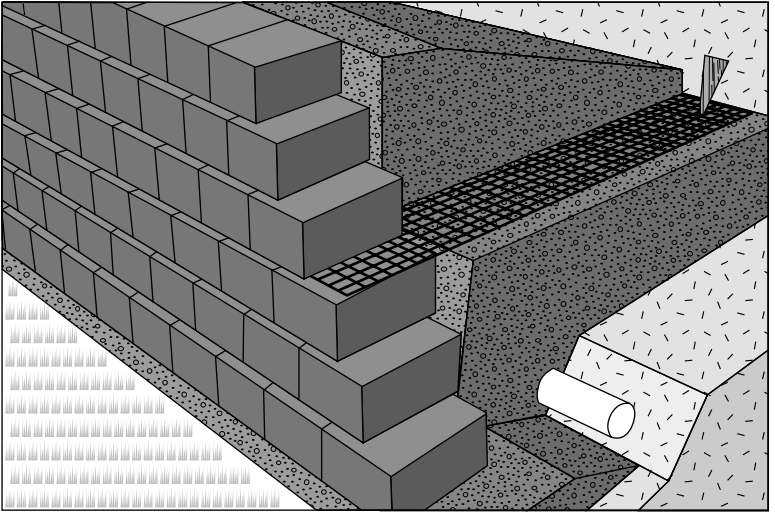

Figure 38. Backfilling over geogrid.

Splitting

The tools required for manually splitting paver or wall units are either the hammer and chisel or the guillotine.

Hammer and chisel - When working with the hammer and chisel, score the unit being split along an imaginary line running all the way around until the unit comes apart. (Figure 39) Use even and consistently weighted blows for best results. When the unit is completely scored, use a heavy blow to finish the split. To split coping or wall units, be sure that the units are sitting level. Make sure there are no stones or pebbles underneath the unit. Split the double unit along the splitting groove provided. Always score the short sides first.

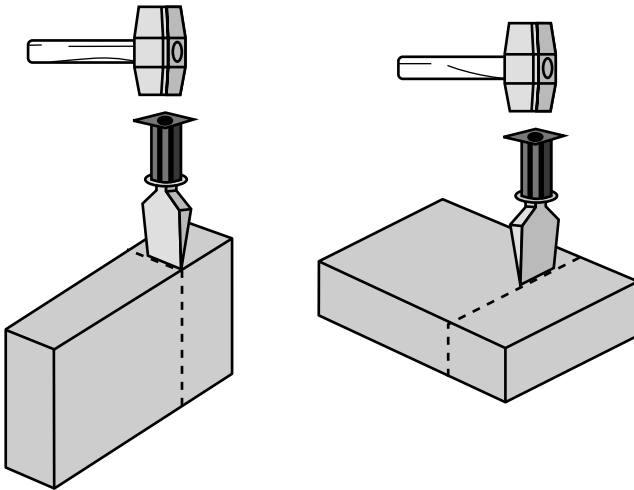

Figure 39. Score wall or paver units first to achieve uniform splitting.

The guillotine is a more accurate method to split paver or wall units. (Figure 40) Simply place the unit between the two blades and adjust the blade until they touch the surface of the concrete. Pull down on the handle to split units. Always wear protective goggles when splitting concrete.

Note: Some units may be too large for a guillotine cutter. Check your guillotine capabilities.

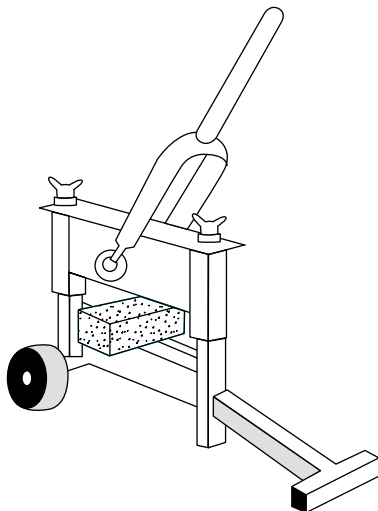

Figure 40. Guillotine gives a fast dust-free cut.

Corners

Outside corners

Generally all Unilock® Retaining Wall Systems have manufactured corner units. They are normally precasted as a left and right unit. Both must be used to create an interlocked corner. With some Unilock® wall systems, Unilock® Concrete Adhesive becomes the locking mechanism between corner units.

Installation - Units are placed on one course leading to the corner. The corner unit is positioned so both rough faces (if there is one) will be exposed in the final construction. Then, standard units are placed on the same course of the adjacent wall. A corner unit from the other direction is placed on the next course to interlock the corner. More standard units need to be placed to complete the course on both walls. The process is repeated as required. (Figure 41)

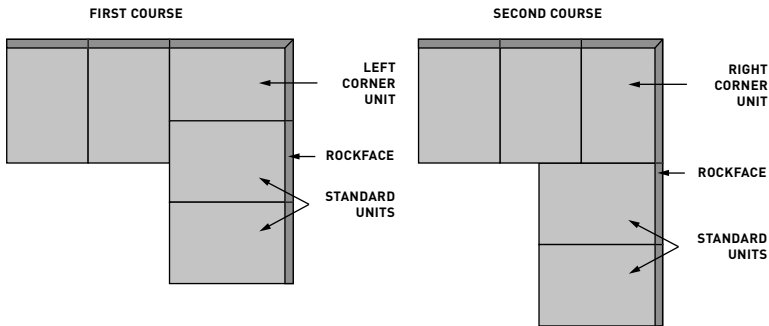

Figure 41. Outside corner typical installation.

Inside corners

Inside corners are required where two walls intersect, and the angle between the faces is less than 180 degrees.

Installation - The installation starts by placing units on one course leading to the corner. A corner unit is placed so that the small face will be hidden behind the final construction. On some corner units, it may be necessary to smooth out the split face within 2/3 of the end. Standard units are placed as shown in Figure 42. The back of these units will extend past the end of the corner unit. A corner unit from the other direction is placed on the next course to interlock the corner. More standard units are placed to complete the course. The process is repeated as required.

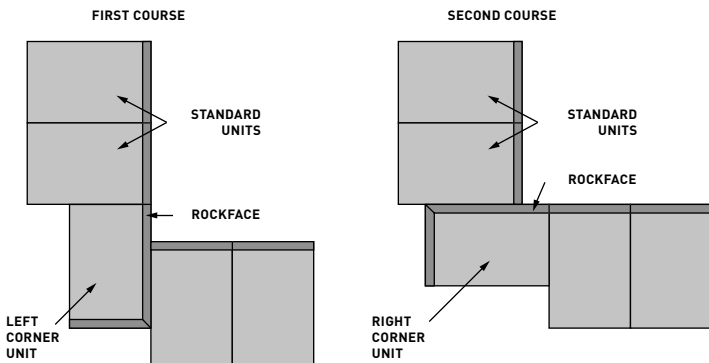

Figure 42. Inside corner typical installation.

Inside curves - Concave walls

Each Unilock® wall system has its own minimum radius for an inside or concave curve. Check specific product information. Smaller radii than specified can be achieved, but this will require cutting. Refer to Table 2 (Page 9) for all the Unilock® wall systems that can be curved.

Installation - The inside curve is constructed using standard units. (Figure 43) The faces of the units must be placed tightly together. Depending on the desired radius, small gaps should be placed at the back. The smallest radius will occur on the bottom course. Each additional course will result in an increase by the wall setback in the radius. Also, the vertical joints will start to line up on successive courses, making it necessary to place half units at random locations.

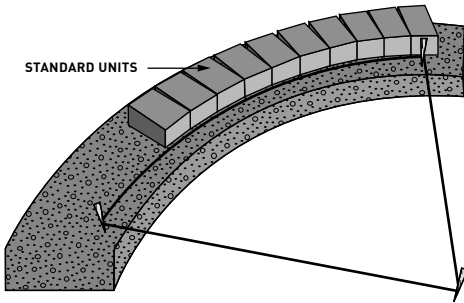

Figure 43. On inside or concave curves, the radius will increase with height.

Outside curves

Almost all Unilock® wall systems have tapered units to construct outside or convex curves. (Figure 44) The minimum radius for this type of curve varies among each system. Refer to specific product information. Some wall systems have units that are extra tapered; they can be used to create a tighter radius. Smaller radii can be achieved, but this will require cutting. Refer to Table 2 for Unilock® wall systems that can be curved.

Installation - An outside curve must be constructed using tapered units. To create smooth flowing curves, it is better to use the tapered "lefts" on one row and then tapered "rights" on the next row. The faces of the units must be placed tightly together. Depending on the radius of the curve, it may be necessary to have small gaps between the back corners of adjacent units. Large radius walls can be created by adjusting the placement of the units. Coping units will have to be cut to finish the wall.

In preparation for the bottom course, it is important to consider that the radius will decrease by the wall setback every course. Therefore, the smallest curve will result on the uppermost course. Also, the vertical joints will start to line up on successive courses, making it necessary to place half units at random locations.

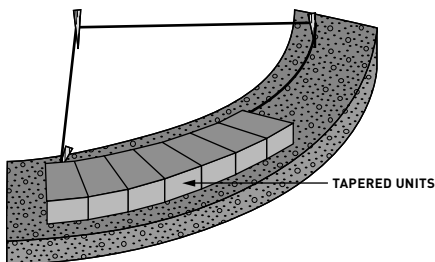

Figure 44. For outside or convex curves, the radius will decrease with height.

Steps

The principles used to build walls and corners are required to apply when constructing steps. Standard or tapered wall units act as risers and coping units act as treads. (Figure 45) Coping units from large wall systems can also be used as steps. They can be created in a number of different configurations. In all cases, compaction is critical to stability of the steps.

Steps require important planning. Outdoor steps should not be more than 6" (15 cm) in height or less than 4" (10 cm). The lower the step, the deeper the tread should be. The ideal step configuration should be close to these measurements.

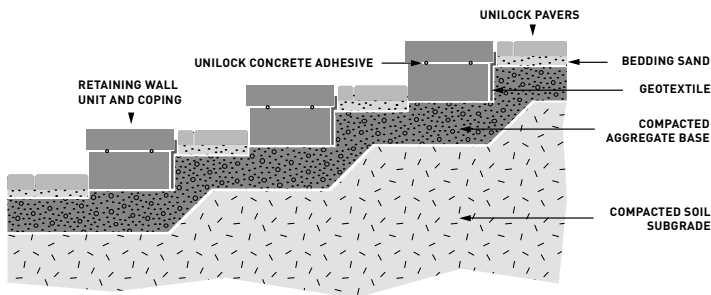

Figure 45. Typical steps installation.

Most common configurations

L-shaped and pyramid steps - These structures are simply a wall with an inside and outside corner, and the course of the wall between the two corner steps back at 12" (300 mm) per course. After an entire riser is placed, the coping stone is then positioned on top and secured with Unilock® Concrete Adhesive. On the systems that have a tongue-in-groove locking system, some trimming of the locking key on the outside corner unit will be necessary on each course. The next riser is then positioned so the face of the unit is in contact with the back of the coping stone on the lower step. All proper backfill and compaction procedures must be followed. Be sure to place filter fabric along the back of the units to prevent washout of the fill. For extra stability, an extra course of units should be placed under the bottom step and adjacent walls. (Figure 46)

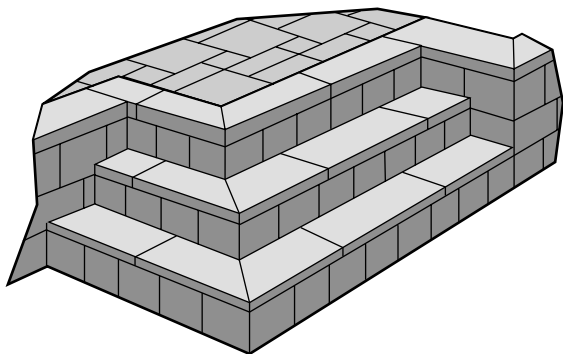

Figure 46. L-shaped and pyramid steps.

Protruding steps - This structure is constructed in the same manner as the L-shaped steps, one course at a time. However, in this arrangement, it is necessary to construct two inside corners and two outside corners. The sidewalls can be built in either battered or vertical arrangement. If the sides batter toward each other, each riser will be narrower than the course below. (Figure 47)

Inset steps - The risers in this type of step are best constructed so that they are independent of the sidewalls. The foundation for the sidewalls can be stepped up (see grade changes on page 38), but the side of the riser units must be in contact with the face of the units in the sidewall. The second phase is to install the risers. The first units must be placed on the same foundation elevation as the sidewalls. A unit will have to be cut to make each riser fit between the sidewalls. All proper backfill and compaction procedures should be followed. Be sure to place filter fabric along the back of the units to prevent washout of the fill.

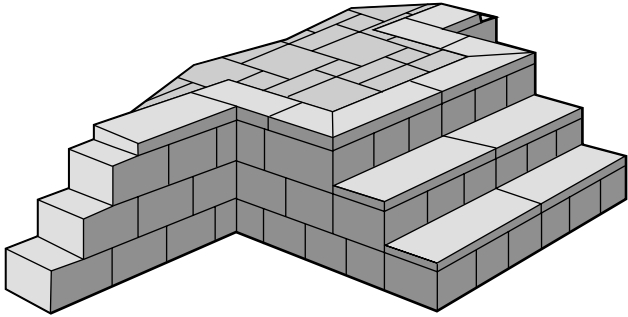

Figure 47. Protruding steps.

The coping is then cut, positioned and secured with Unilock® Concrete Adhesive. Successive courses are then placed. If the sidewalls are being built battered (with a setback), they will slope away from each other by the "system specific setback" per course. In this case, each riser will be wider than the course below. (Figure 48)

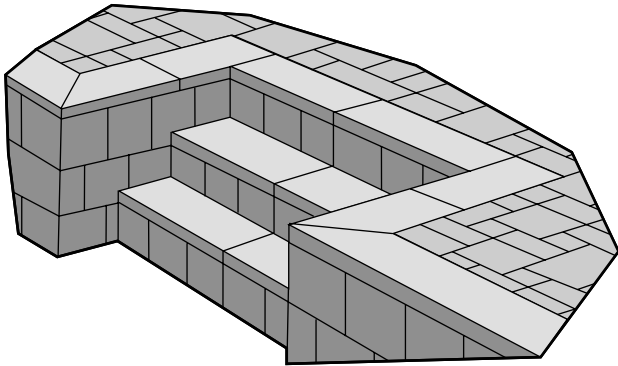

Figure 48. Inset steps.

Steps with infill landings - The construction of steps with infill landings is no different from the construction of steps without landings except for the positioning of the higher steps. Once the first step is installed, lay a few pavers in the appropriate pattern to determine the best position of the next riser. This will minimize cutting the pavers. Make sure the pavers are $\frac{1}{2}$ " (13 mm) above the height of the coping when installed, so they can be tamped down to the level of the coping. (Figure 49)

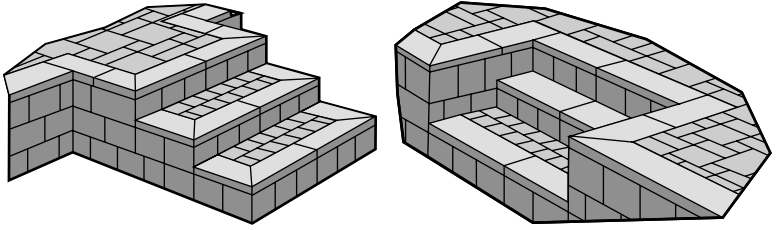

Figure 49. Steps with infill landings.

Large coping unit steps - These structures are basically constructed with coping units from large wall systems. After the first riser is placed with a single coping unit, the granular material at the back of the first step is placed at the same top elevation after compaction. The second riser is then positioned so the face of the next coping unit is in contact with the back of the coping stone on the lower step. Repeat the previous stages to finish the steps as required. All proper back-fill and compaction procedures must be followed. (Figure 50)

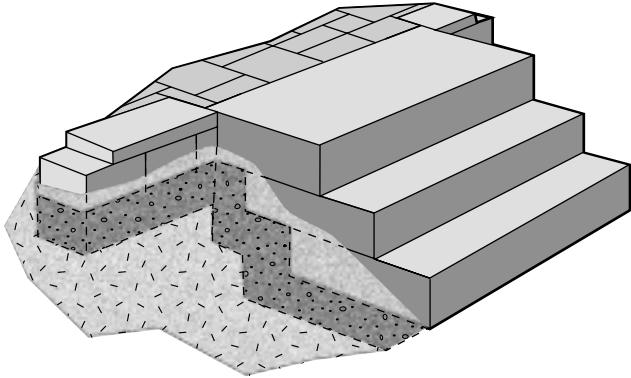

Figure 50. Large coping unit steps.

Steps installation tips

- Leveling for steps is done the same way as it is done for building retaining walls.
- Always level left to right and from front to back. Specialty levels are available for some products.
- Units may need to be cut in order to fit around obstacles.
- Any lighting planned in steps or walls should be installed early on.

- As with raised patios and walls, always "dry-fit" the coping before gluing them down.
- Placing a filter fabric behind the steps will prevent sand from seeping between the joints and help in preventing settlement.
- Before gluing the coping, always clean the surface with a small broom. The area should be clean and dry.
- Fill in the area behind the steps with base material and compact, using a hand tamper. Be careful when compacting that you do not deflect the wall units out of alignment.
- When constructing infill steps, temporarily lay a row of pavers in order to locate the position of the next step.
- The alignment and positioning of steps is critical. Constantly check measurements as you go.
- To miter corners, mark out an equilateral triangle on the end of a coping unit, and then cut it with a masonry saw.
- Coping may need to be mitered or "rock-faced", depending on the design of the job.
- After the top step riser is installed, the coping is fitted and glued.
- The steps are completed by installing pavers in the areas behind the steps, using the procedures as described in the paver installation section.

Planters

Planters are constructed similar to steps and walls. (Figure 51) Low planters, fewer than 12" (300 mm), can be filled directly with topsoil. Larger planters need to be filled up half way with gravel, then covered with filter fabric, and then filled with soil. Giving a soft compaction to the soil will prevent settlement of the plants and soil level later.

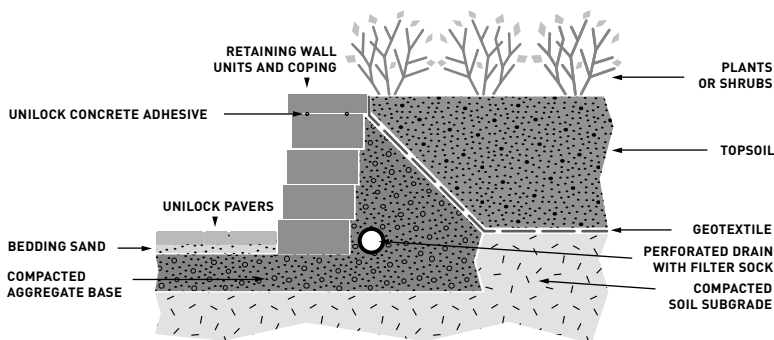

Figure 51. Typical planter application.

Pillars can be constructed with several of Unilock®'s wall systems. It is like building a retaining wall with only corner units. The base required depends on climate and local building codes. We recommend two courses minimum of wall units below grade on a 12" (300 mm) base of crushed gravel. (Figure 52)

Before construction begins, be sure to place in an approved electrical cable if a lamppost is being constructed. Local building codes for buried cable requirements must be followed. Depending on the style of the wall unit, some cutting of the wall units may be required. Each course needs to be glued. The top of the pillar can be capped using coping units. Glue them securely to the top using Unilock® Concrete Adhesive. Once the adhesive is dry (24 hours), the light can be connected and mounted.

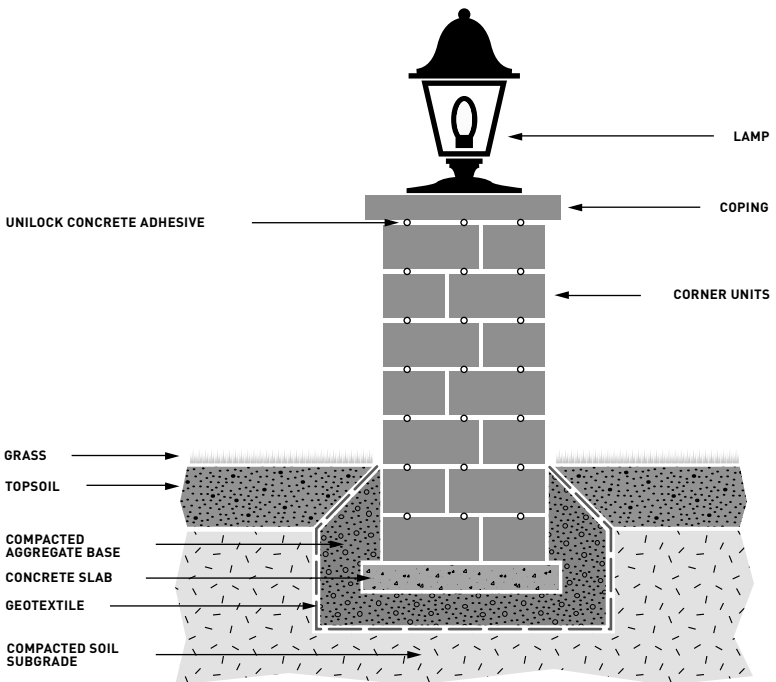

Figure 52. Typical pillar installation.

PAVERS MAINTENANCE GUIDE

When correctly installed and maintained, all Unilock® products will provide a durable and pleasing surface for years to come. However, like many other construction projects, periodic maintenance will preserve the serviceability, beauty and integrity of the installation.

The joints between paving stones are undoubtedly the most vulnerable areas of any paving stone installation. Depending on the climate and amount of use, even the most expertly installed patio may require attention to the joints at some time in its life.

When using a power wash tool or garden hose to clean the paved area, the water should be directed at the surface at an angle not greater than 30 degrees and across the diagonal (i.e. not parallel to the joints as the water can be harsh and break up the jointing material).

Any cleaning product used must be thoroughly rinsed from the surface and channeled to suitable drainage points. Once the area has been cleaned, it should be inspected to ensure the integrity of the sand joint and any eroded joints should be re-sanded as necessary

Cleaning

A regular cleaning routine using a stable broom and a good detergent, followed by the application of a weed preventative will help maintain the beauty and keep the splendor of any paver installation. We recommend that you follow our recommendations outlined below.

Cleaning is also an essential step in preparation for sealing concrete pavers. Prior to cleaning, the area should be inspected for any cracked or broken units. These should be replaced. Adjacent tree branches, shrubs and vegetation should be pulled back or covered to protect from overspray of cleaning solutions. Protective clothing and goggles should be worn when working with acid-based solutions.

Consider where the cleaning fluids will drain. They should drain across the pavement and not onto the grass or vegetation. Do not let silt or cleaners stand in low spots as this may strain the pavers. Be sure to rinse these areas thoroughly. Automatic sprinkler systems should be turned off during cleaning and sealing operations.

When using all cleaning solutions, and especially those containing acids, a small, inconspicuous area should be cleaned to test for surface and color reaction. Acid cleaners will dissolve a thin layer of cement on the surface of the pavers, so the color of the pavement may change slightly. Always follow label directions for use,

application, precaution and first aid. ALWAYS REFER TO MSDS. Contact 1-800-UNILOCK or visit www.unilock.com, if you require a copy.

An efficient method of overall cleaning is high-pressure spray. Some systems mix water and a cleaner together in the spray. Care should be taken to not blow or wash the sand from the joints. Sand will remain in the joints if a wide spray nozzle is used and the angle of the spray is kept from directly penetrating the joints. As with a cleaning job, a small area should be tried first to test the result of the spray. Never spray so close to the stone that you damage the appearance of the surface.

Grease and oil stains

Oil will penetrate readily into a paved area, but will not stain if any spillage is removed promptly with an absorbent material (e.g. paper towels or cloth). The spillage should be soaked up, not rubbed, as this will spread it over a large area, driving the stain deeper into the concrete.

Unilock® Oil & Dirt Remover - Is the most effective product available for removing oil spots from paving stones and concrete. Unilock® Oil & Dirt Remover dissolves, dislodges and encapsulates oil to ensure thorough cleaning, without leaving any oily film after rinsing. Always follow label directions for use, application, precaution and first aid.

Efflorescence on concrete

Efflorescence is a naturally occurring calcium salt that sometimes appears on the surface of concrete-based building materials and clay products. As the cement and water chemically react together, calcium hydroxide is produced. As the concrete dries, the calcium hydroxide reacts with the carbon dioxide in the atmosphere to produce calcium carbonate, which manifest as a white solid. Repeated exposure to wetting and drying accelerates the "wicking" of the calcium to the surface.

The occurrence of efflorescence in the pores of the concrete can lead to the appearance of white patches on the surface or an overall lightening of the product, which is often mistaken for the product fading. Although the appearance of efflorescence can be worrying, the effects of efflorescence are purely aesthetic and do not alter the strength or durability of the concrete pavers. This normally goes away naturally after a season of rainfall. It is possible to accelerate its removal by washing with Unilock® Efflorescence Remover.

Unilock® Efflorescence Remover - Is specially formulated to dissolve efflorescence and remove ground-in dirt on paving stones and concrete, without discoloring or damaging surfaces. It cleans evenly, and enables the sealant to better penetrate the pavers. Always follow label directions for use, application, precaution and first aid.

Rust stains

Rust stains arise from water running over oxidizing (rusting) metal objects and then staining the surface.

Unilock® Rust Remover - Cleans rust from paving stones and concrete, without discoloring the surface. Short-term stains caused by metal objects sitting on the surface can be easily removed with this cleaner. Rust stains caused by metal scrapings from equipment such as snow removers may be difficult to remove. It is recommended that Efflorescence Remover be used after cleaning rust stains, so that all areas will have a more uniform appearance from cleaning. Always follow label directions for use, application, precaution and first aid.

Tar, rubber and paint stains

Unilock® Paint, Tar & Rubber Remover - Will dissolve paint, tar and even chewing gum from pavers, concrete and masonry. Often used to clean high traffic areas where vehicles turning sharply may cause unsightly tire marks. This cleaner works best when allowed to soak into the stain for 5 to 10 minutes prior to rinsing. Use the cleaner a second time if necessary. This product will dissolve sealer, making re-sealing necessary. Always follow label directions for use, application, precaution and first aid.

Sealing

Sealants can inhibit staining and enhance the color of concrete pavers. They are useful around pools, BBQs, driveways, trash receptacles and other areas subject to stains, and where oil dripping may occur. Sealers are also used to stabilize joint sand.

Application of Sealants - Concrete pavers must be subjected to repeated exposure of moisture and evaporation prior to cleaning and application of sealers. Repeated cycles of moisture and evaporation will cause efflorescence near the surface to come to the surface of the pavers. All dirt, oil and efflorescence must be cleaned prior to sealing.

The cleaned surface must be completely dry prior to applying sealers. If the surface is not dry, or there is efflorescence under the pavers (i.e. in the sand, base or soil), sealed pavers will draw the efflorescence to the surface. The applied sealer can become cloudy and diminish the appearance of the pavers. Sealers can be applied with a foam hand roller if the area is small (under 400 sq. ft. or 37 sq. m). For larger areas where a more efficient application is needed, a low-pressure sprayer is recommended. Follow the instructions for the best method and protective gear to be worn during the job. Block the area from traffic once the sealer is applied until the sealer is completely dry. Sealers may require re-application after a couple of years.

Solvent and water base protective sealer

Unilock® Water Base Protective Sealer - It is a thermoplastic acrylic emulsion, whitish in color in liquid state, it becomes clear when dry. Since it contains very little solvent, it does not emit unpleasant odors, and is therefore ideal for interior applications. It gives a satin finish, which practically does not affect the original color of the concrete surface.

Unilock® Solvent Base Protective Sealer - It is a transparent resin that is specially designed to protect concrete pavers, slabs and other concrete surfaces. It intensifies the color of the pavers or slabs and gives them a semi-gloss finish.

Both types of Unilock® protective sealers penetrate the concrete deeply for maximum effectiveness and durability. Sealers facilitate maintenance by reducing oil and dirt penetration. Neither protective sealer will peel, discolor or make the pavement slippery. They resist the elements (freeze-thaw cycles, sun, snow, rain, etc.) as well as de-icing salts and products.

Joint sand stabilizer and paver sealer

Unilock® Joint Sand Stabilizer & Paver Sealer is dual-functioning. It is a clear microporous acrylic emulsion designed to protect the surface while bonding the joint sand in place. Its superior penetration and adhesion properties keep joint sand in place, preventing erosion, weed growth and insect infestation. It also reduces oil and dirt penetration, which makes cleaning easier. By stabilizing the joint sand, you also prevent sand from tracking into the house or pool. Once set, it remains flexible, allowing it to accept the movements of pavers and slabs in varying climatic conditions. This product will not peel or discolor. Its water-based formulation makes it is easy to apply and odor-free. This product contains very little solvent, making it an environmentally friendly product.

Polymeric sand

The infiltration of rainwater or other sources assists the sand to be washed out of the joints. It is important that these joints are topped up with jointing sand to prevent the loss of interlocking, allowing the pavers to move independently. To prevent this from occurring, it is strongly recommend that paving joints be filled with Unilock® Polymeric Sand. Although regular jointing is acceptable for most applications, it is critical to prevent the sand from being washed and blown out of the joints. Sloped areas or areas around swimming pools should have Unilock® Polymeric Sand swept into the joints at the time of installation.

Unilock® Polymeric Jointing Sand is a mix of graded sand and binder, especially formulated for the filling of narrow or wide joints between pavers. Unlike regular sand, this sand resists insect infestation, weed growth and erosion caused by rain, frost, wind, suction, etc. It is ideal for stabilizing horizontal or sloped installations, such as driveways, patios, pool decks, pedestrian ways, parking lots,

roadways, airport traffic areas, etc. This product allows for some movement of the pavers without loss of the jointing sand. It is applied dry and hardens after moistening.

Use of chemicals & acids

When using chemicals for the cleaning of paving stones, the manufacturer's instructions should be carefully read and strictly adhered to. In general, the following precautions should be taken:

- When using chemicals, protective clothing such as gloves, goggles, boots and overalls should be worn.
- Proper ventilation is required to confined spaces when using chemicals.
- When using any chemicals, care must be taken not to damage, contaminate or stain any adjoining material.
- When diluting acids, ALWAYS add acid to water and not water to acid.
- Any clothing that is contaminated with chemicals should be disposed of safely.
- Care must be taken to protect personnel operating in the area of the cleaning from an injury or hazard created by the cleaning.
- Care must be taken in the disposal of any runoff material.
- Empty containers must be disposed of at your local household hazardous waste return facility.

BOSTON

35 Commerce Drive
Uxbridge, MA 01569
Tel: (508) 278-4536
Fax: (508) 278-4572

BUFFALO

510 Smith St.
Buffalo, NY 14210
Tel: (716) 822-6074
Fax: (716) 822-6076

CHICAGO

301 E. Sullivan Road
Aurora, IL 60504
Tel: (630) 892-9191
Fax: (630) 892-9215

CLEVELAND

12560 Sheets Road
Rittman, OH 44270
Tel: (330) 927-4000
Fax: (330) 927-4100

DETROIT

12591 Emerson Drive
Brighton, MI 48116
Tel: (248) 437-7037
Fax: (248) 437-4619

MILWAUKEE

West 4814 County
Highway A
Elkhorn, WI 53121
Tel: (262) 742-3890

NEW YORK

51 International Blvd.
Brewster, NY 10509
Tel: (845) 278-6700
Fax: (845) 278-6788

PHILADELPHIA

229 Route 541 Bypass
Lumberton, NJ 08048
Tel: (609) 914-0000
Fax: (609) 914-0209

TORONTO

287 Armstrong Ave.
Georgetown, ON L7G 4X6
Tel: (416) 646-9000
Fax: (905) 874-3034

COMING SOON

Columbus, Ohio
Chester, New York

OVER 30 YEARS OF INNOVATION

The logo for UNILOCK, featuring the word "UNILOCK" in a bold, sans-serif font with a registered trademark symbol. The letters are white and set against a dark grey rectangular background.

www.unilock.com | 1-800-UNILOCK

Designed to be a step ahead®